

CONTENTS

Chapter No.	Name of the chapter	No. of periods	Pg. No.
1.	Stones	10	1
2.	Bricks	10	16
3.	Cement	10	43
4.	Sand	10	54
5.	Mortar	09	60
6.	Concrete	10	70
7.	Timber	09	80
8.	Miscellaneous Building Materials	20	95
9.	Types of Buildings	05	120
10.	Foundations	15	132
11.	Masonry	05	156
12.	Floors	07	194
13.	Roofs	10	208
14.	Damp proof & Fire proof Construction	07	233

MODEL PAPER

REFERENCE BOOKS

INDEX

INDEX

A

Appliances for lifting stones
Ashlar masonry

B

Bearing power of soil
Black cotton soil
Bonds in brickwork
Brick masonry
Brick Partitions
Built-up sections
Bulking of sand
Buttresses

C

Causes of dampness
Cavity walls
Cement concrete construction
Cement concrete piles
Composite floors
Composite masonry
Concrete mixers

Concrete sheet piles
Cost of formwork
Curing of concrete
Curved roofs

D

Damp proofing
Dead load
Doors and windows
Double roofs
Drainage of pitched and flat roofs
Dressing of stone surfaces

E

Earth rammers
Effects of dampness
External finishes

F

Fire protection in buildings
Fire protection systems
Floors and floorings
Footings
Formwork

Foundations for machines
Framed structures

G

Grading of aggregates
Grillage foundations
Group of piles
Guniting

I

Increasing the bearing
power of soil

J

Joints in stone masonry
Junctions

K

King-post truss

L

Lightweight concrete
Live load
Load bearing piles
Loads on foundations

M

Method of dropping a
weight
Methods of damp-proofing

Methods of sound
insulation
Methods of timbering

O

Objects of foundations
Ornamental brickwork

P

Partitions
Piers
Pile foundations
Pile hammers
Pitched roofs
Plastering
Pointed arch
Pointing
Pre-cast concrete
Proportioning concrete
Purlin roofs

Q

Quality control of concrete
Queen-post truss
Quoins

R

Raft foundations
Reinforced brickwork
Retaining walls

Roof coverings for pitched roofs

Roofs

Router

Round bars

Rubble masonry

S

Sand piles

Scaffolding

Screw piles

Shoring

Single roofs

Stairs

Stone masonry

Structures in brickwork

T

Timber floors

Timber piles

Timber sheet piles

Tools used in brick masonry

Tools used in stone masonry

Trussed roofs

Types of floorings

U

Uses of piles

V

Ventilation

Ventilators in pitched roofs

Vibrators

W

Wall paper

Water-cement ratio

Water proofing of flat roofs

Wedges

Wells

Window sills

Workability

Z

Zig-zag Bond

CHAPTER-1

STONES

1.0 Introduction:

All the building structures are composed of different types of materials. These materials are either called building materials or materials of construction. It is very essential for a builder, may be an architecture or engineer or contractor, to become conversant thoroughly with these building materials. The knowledge of different types of material, their properties and uses for different purposes provides an important tool in the hands of the builders in achieving economy in material cost. The material cost in a building ranges 30 to 50 percent cost of total cost construction. In addition to material economy, the correct use of material results in better structural strength, functional efficiency and esthetic appearance.

1.1 Classification of Rocks:

Building stones are obtained from rocks occurring in nature and classified in three ways.

1. Geological classification
2. Physical classification
3. Chemical classification

I. Geological Classification:

According to this classification, the rocks are of the following types.

- a. **Igneous rocks:** Rocks that are formed by cooling of magma (molten or pasty rocky material) are known as igneous rocks. Eg: Granite, Basalt and Dolerite etc.
- b. **Sedimentary rocks:** these rocks are formed by the deposition of products of weathering on the pre-existing rocks. Examples: gravel, sandstone, limestone, gypsum, lignite etc.
- c. **Metamorphic rocks.** These rocks are formed by the change in character of the pre-existing rocks. Igneous as well as sedimentary rocks are changed in character when they are subject to great heat and pressure. Known as metamorphism. Examples: Quartzite, Schist, Slate, Marble and Gneisses.

II. Physical Classification:

This classification based on general structure of rocks.

According to this, the rocks are classified into three types

- a. **Stratified Rocks:** These rocks possess planes of stratification or cleavage and such rocks can be easily split along these planes
Ex: sedimentary rocks
- b. **An stratified rocks:** The structure may be crystalline granular or compact granular. Examples: Igneous rocks and Sedimentary rocks affected by movements of the earth.
- c. **Foliated Rocks:** These rocks have a tendency to split up in a definite direction only. Ex: Metamorphic rocks.

III. Chemical Classification:

According to this classification rocks are classified into three types.

a. Siliceous rocks: In these rocks, silica is predominates. The rocks are hard; durable and not easily effected by weathering agencies. Ex: Granite, Quartzite, etc.

b. Argillaceous Rocks: In these rocks, clay predominates. The rocks may be dense and compact or may be soft.

Ex: slates, Laterites etc.

c. Calcareous rocks: In these rocks, calcium carbonate predominates. The durability to these rocks will depend upon the constituents present in surrounding atmosphere. Ex: Lime Stone, marble etc.

1.2 Uses of stones:

1. **Structure:** Stones are used for foundations, walls, columns, lintels, arches, roofs, floors, damp proof course etc.

2. **Face works.** Stones are adopted to give massive appearance to the structure. Wall are of bricks and facing is done in stones of desired shades. This is known as composite masonry.

3. **Paving stones:** These are used to cover floor of building of various types such as residential, commercial, industrial etc. They are also adopted to form paving of roads, foot paths etc.

4. **Basic material:** Stones are disintegrated and converted to form a basic material for cement concrete, morum of roads, calcareous cements, artificial stones, hallow blocks etc.

5. **Misalliances:** Stones are also used for (i) ballast for railways (ii) flux in blast furnace (iii) Blocks in the construction of bridges, piers, abutments, retaining walls, light houses, dams etc.

1.3 Qualities of a good building stone:

The following are the qualities or requirements of a good building stone.

1. **Crushing strength:** For a good building stone, the crushing strength should be greater than 1000kg per cm².
2. **Appearance:** Good building stone should be a uniform colour, and free from clay holes, spots of other colour bands etc capable of preserving the colour for longtime.
3. **Durability:** A good building stone should be durable. The factors like heat and cold alternative wet and dry, dissolved gases in rain, high wind velocity etc affect the durability.
4. **Fracture:** For good building stone its fracture should be sharp, even and clear.
5. **Hardness:** The hardness greater than 17, treated as hard used in road works. It is between 14 to 17, medium hardness, less 14 said be poor hardness.
6. **Percentage wear:** For a good building stone, the percentage wear should be equal to or less then 3 percent.
7. **Resistance to fire:** A good building stone be fire proof. Sandstone, Argillaceous stone resists fire quite well
8. **Specific gravity:** For a good building stone the specific gravity should be greater then 8.7 or so.
9. **Texture:** A good building stone should have compact fine crystalline structure should be free from cavities, cracks or patches of stuff or loose material.

10. **Water absorption:** For a good building stone, the percentage absorption by weight after 24 hours should not exceed 0.60.
11. **Seasoning:** Stones should be well seasoned before putting into use. A period of about 6 to 12 months is considered to be sufficient for proper seasoning.
12. **Toughness Index:** Impact test, the value of toughness less than 13 – Not tough, between 13 and 19 – Moderate, greater than 19- high

1.4 Characteristics of stones

In order to ensure suitable selection of stone of particular work, one must be conversant with its composition, characteristics, uses and place of availability.

1.4.1 Granite

1. Igneous rock
2. Composed of quartz, feldspar and mica and minerals
3. Available in grey, green, brown and pink and red
4. Hard and durable
5. High resistance to weathering
6. The texture varies with its quality
7. Specific gravity 2.7 and compressive strength 700 to 1300 kg/cm²
8. Used for ornamental, road metal, railway ballast, aggregate for concrete; for construction of bridges, piers and marine works etc.

1.4.2 Balast

1. Igneous rock
2. It is compact, hard and heavy
3. Available in red, yellow grey, blue and greenish black colour
4. Specific gravity is 3 and compressive strength varies 1530 to 1890 kg/cm².
5. Used for ornamental, rail road ballast, aggregates for concrete etc.

1.4.3 Sand Stone:

1. Sedimentary rock
2. It is available in variety of formations fine grained, coarse grained compact or porous
3. Available in white, green, blue, black, red and yellow.
4. Specific gravity 2.65 to 2.95
5. Compressive strength is 650kgs / cm²
6. Used for ashlar works

1.4.4 Lime Stone:

1. Sedimentary rock: It is available in a variety of forms which differ from one another in colour Compaction, texture, hardness and durable
 - a. Compact lime stone
 - b. Granular lime stone
 - c. Magnesia lime stone
 - d. Kanker lime stone
 - f. Used for paving, road metal, etc

1.4.5 Marble

1. Metamorphic rock
2. Available in white, blue, green, yellow black and red colour
3. High compactness,
4. Suitable for decorative works, wall lining columns, pile, table slabs, hearths, tiled floors, steps of stair case etc.

1.4.6 Slate:

1. Metamorphic rock
1. Non absorbent, compact fine grained and produce metallic ringing sound when struck
2. Available in black, dark blue, grey, reddish brown etc.
3. Used for providing damp proof course, paving dados etc

1.5. Selection of stones

In contemplating the use of stone for various engineering works, the selection of the nature and quality of stone is governed by the purpose in view, cost of stone, its ornamental value and durability Suitability various types of stones for different purposes and situation is briefly discussed below

- a. For face work, in general marble, granite and close-grained sand stone are used in the form of thin slabs (veneers) where the structure subjected to adverse weather effects.
- b. For pillars, balustrade, pedestals, columns statues and door and window sill and paving stone, granite marble and

compact lime stone can be recommend because they can take good polish.

- c. For ornamental works such as moulding and carvings, fine-grained sand stone, fine grained marble and fine grained granite are used.
- d. For bridges, piers, docks, break-waters and other marine structures the stone should be very hard, heavy, strong and durable granite and gneiss are recommended for this purpose
- e. For road metal, stones should be hard, tough, resistant to abrasion and durable. Basalt and course-grained granite are generally recommended for this purpose.
- f. For railway ballast, the stone should be hard, dense, durable, tough and easily workable sandstone, compact lime stone, trap and quartzite are commonly used
- g. In situation like steps, doors sills, pavings etc where there is a regular flow of traffic, stone should be hard, dense, easily workable and durable. Marble, slates and sand stones are commonly use in such places.
- h. In fire proof construction, compact sand stone should always be preferred.

1.6 Artificial stones: These are also known as cast stones or reconstructed stones. Artificial stones may take up various forms such as

a. Cement concrete: This is the mixture of cement, fine aggregates, coarse aggregates and water. It may be cast in site

or pre-cast if steel is used with cement concrete, it is known as reinforced cement concrete.

b. Mosaic tiles: Pre-Cast concrete tiles with marble chips at top surface are known as tiles. They are available in different shades and widely adopted at present.

c. Terrazo : This is a mixture of marble chips and cement. It is used for bathrooms residential buildings, temples etc.

Advantages of artificial stones:

1. Cavities may be kept in artificial stones to convey pipes, electric wires etc.
2. Grooves can be kept in artificial stone while it is being cast which are useful for fixing various fittings.
3. It can cast in desired shape
4. It can be made in a single piece and hence trouble of getting large blocks of stone for lintels, beams etc is avoided.
5. It can be made stronger than natural stone
6. It is cheap and economical
7. It is more durable than natural stone
8. Natural bed is absent in artificial stones and hence, the question of taking precautions with respect to the natural bed of stones does not arise.

1.7 Aggregates - Grading: Aggregates is derived from igneous, sedimentary and metamorphic rocks or is manufacture from clays, slag etc. The properties of concrete are directly related to those of its constituents and should be hard, strong,

durable, and free from clay, loam, vegetables and other such foreign matters. The presence of clay or dirt coating prevents the adhesion of cement on the surface of aggregates and ultimately retards the setting and hardening of cement and reduces the strength, durability and soundness of concrete.

Depending upon their size, the aggregates are classified as (i) Fine Aggregative (ii) coarse aggregates.

- (i) **Fine Aggregates:** The material, most of when passes through 4.75mm I.S. sieve size, is termed as fine aggregates. It should not contain more than 1 to 8% of fine particles, which may be obtained from sea, river, lake or pit may be used as fine aggregates but care should be taken all its impurities must be removed
- (ii) **Coarse Aggregates:** The material whose particles are of such size as are retained on 4.75mm, I.S sieve are called coarse aggregates. The size of the coarse aggregates used depends upon the nature of work. The maximum size may be 23mm for mass concrete such as dams etc. and 63mm for plain concrete. Crushed hard stone and gravel is the common materials used as coarse aggregates for structural concretes. Coarse aggregates usually obtained by crashing granite, gneiss, crystalline lime stone and good variety of sandstone etc.

Grading of Aggregates:

Grading of aggregates consists of proportionating the fine and coarse aggregates in such a ratio, so as to get strongest and densest mix with the least amount of cement.

Grading the aggregates is so graded as to have minimum voids when mixed with all ingredients, and water should render a concrete mass of easy workability.

The grading of aggregates are done by the following methods

- (i) **By trail** – In this method, proportionating of aggregates as to give heaviest weight for same volume, yield the densest concrete
- (ii) **By finesse modulus method (sieve analysis method):** in this method, the samples of both coarse and fine aggregates are passed through a set of nine standard sieve and the percentage of sample retained on each of the said sieves is determined. The total of these percentages divided by 100 gives the finesses modulus of sample
- (iii) **By minimum voids method:** This method is based on the fact, that so obtain dense concrete the quantity of cement should also be slightly in excess of voids more that the fine aggregates. In this method the voids in the fine and coarse aggregates are separately found out with the help of graduated cylinder and water. The percentage of voids I aggregate, “X” given by the equation.

$$X = \frac{(V1 - V2)}{V2} \times 100$$

V2

Where v1, volume of water filled

Where v2, volume of aggregates.

- (iv) **By arbitrary standards:** It is a commonly adopted method of propitiating the aggregates in a concrete mix

for small works of moderate importance. This method is not recommended for large works or important works in this method, the volume of cement, sand and coarse aggregates are taken in the proportion of 1:n:2n respectively. The quantity of water to be used a varied suit the workability descried.

Ex: 1:1:2 M250 rich mix for columns, beams
 1:1:3 – M200 Water retaining structures etc
 1:3:6 – M150 slab's columns roads etc
 1:3:6 – M100 – foundations,
 1:4:8 - For mass concrete.

* * *

SYNOPSIS

1. Building stones obtained from rocks occurring in nature is classified into
 - a. Geological classification
 - b. Physical classification
 - c. Chemical classification
2. According or geological classification rocks are classified as
 - a. Igneous rocks
 - b. Sedimentary rocks
 - c. Metamorphic rocks
3. According to physical classification the rocks are classified into
 - a. Stratified rocks
 - b. Unstratified rocks
 - c. Foliated rocks
4. According to chemical classification the rocks are
 - a. Silicious rocks
 - b. Argillaceous rocks
 - c. Calcareous rocks
5. A good building stone should have the following qualities
 - a. Crushing strength
 - b. Appearance
 - c. Durability
 - d. Fracture
 - e. Hardness
 - f. Percentage wear
 - g. Resistance to fire

- h. Specific gravity
 - i. Texture
 - j. Water absorption
 - k. Seasoning
 - l. Toughness index
6. The stones are used for
 - a. Structural work
 - b. Face work
 - c. Paving work
 - d. Basic materials
 - e. Other purposes like ballast for railways; flux in blast furnace etc
 7. The artificial stones are cast stones or reconstructed stones
 - Ex. 1. Cement concrete
 2. Mosaic tiles
 3. Terrazo
 8. The artificial stones are used for to convey pipes, electric wires, fixing various fittings, cast to any shape, stones for lintels or beams etc.
 9. Depending upon their size, the aggregates are classified
 - a. Fine aggregates
 - b. Coarse aggregates
 10. The grading of aggregates are done by
 - a. By trail
 - b. By fineness modulus method
 - c. By minimum voids method
 - d. By arbitrary method

SHORT ANSWER QUESTIONS

1. Name the classification of stones.
2. Name the types of rocks according to geological classification.
3. Define igneous rocks.
4. Define sedimentary rocks.
5. Define metamorphic rocks.
6. Name any four building stones.
7. Name any four good qualities of stones.
8. Name any two uses of stones.

ESSAY TYPE QUESTIONS

1. Explain the classification of stones.
2. Explain in detail about the geological classification of stones.
3. Explain the qualities of good building stone.
4. Explain the uses of stones as building materials.
5. Explain physical and chemical classification of stones.
6. Explain the uses of the following building materials.
a) Marble b) Granite c) Basalt d) Sandstone
7. Explain the grading of aggregates.

* * *

CHAPTER-2

BRICKS

Bricks are obtained by moulding clay in rectangular blocks of uniform size and then by drying and burning these blocks. As bricks are of uniform size, they can be properly arranged, light in weight and hence bricks replace stones.

2.1 Composition - Manufacture Process.

Composition – Following are the constituents of good brick earth.

Alumina: - It is the chief constituent of every kind of clay. A good brick earth should contain 20 to 30 percent of alumina. This constituent imparts plasticity to earth so that it can be moulded. If alumina is present in excess, raw bricks shrink and warp during drying and burning.

Silica-A good brick earth should contain about 50 to 60 percent of silica. Silica exists in clay either as free or combined form. As free sand, it is mechanically mixed with clay and in combined form; it exists in chemical composition with alumina. Presence of silica prevents cracks shrinking and warping of raw bricks. It thus imparts uniform shape to the bricks. Durability of bricks depends on the proper proportion of silica in brick earth. Excess of silica destroys the cohesion between particles and bricks become brittle.

Lime – A small quantity of lime is desirable in finely powdered state to prevent shrinkage of raw bricks. Excess of lime causes the brick to melt and hence, its shape is lost due to the splitting of bricks.

Oxide of iron- A small quantity of oxide of Iron to the extent of 5 to 6 percent is desirable in good brick to imparts red colour to bricks. Excess of oxide of iron makes the bricks dark blue or blackish.

Magnesia- A small quantity of magnesia in brick earth imparts yellow tint to bricks, and decreases shrinkage. But excess of magnesia decreases shrink leads to the decay of bricks.

The ingredients like, lime, iron pyrites, alkalies, pebbles, organic matter should not present in good brick earth

Manufacture of bricks:

The manufacturing of brick, the following operations are involved

1. Preparation of clay
2. Moulding
3. Drying
4. Burning

(i) **Preparation of clay :-** The preparation of clay involves following operations

- a) **Unsoiling :-** Top layer of 20cm depth is removed as it contain impurities.

- b) **Digging:** - Clay dug out from ground is spread on level ground about 60cm to 120cm heaps.
- c) **Cleaning:**-Stones, pebbles, vegetable matter etc removed and converted into powder form.
- d) **Weathering:**- Clay is exposed to atmosphere from few weeks to full season.
- e) **Blending:**- Clay is made loose and any ingredient to be added to it is spread out at top and turning it up and down in vertical direction.
- f) **Tempering:**- Clay is brought to a proper degree of hardness, then water is added to clay and whole mass is kneaded or pressed under the feet of men or cattle for large scale, tempering is usually done in pug mill as shown in the fig 2.1

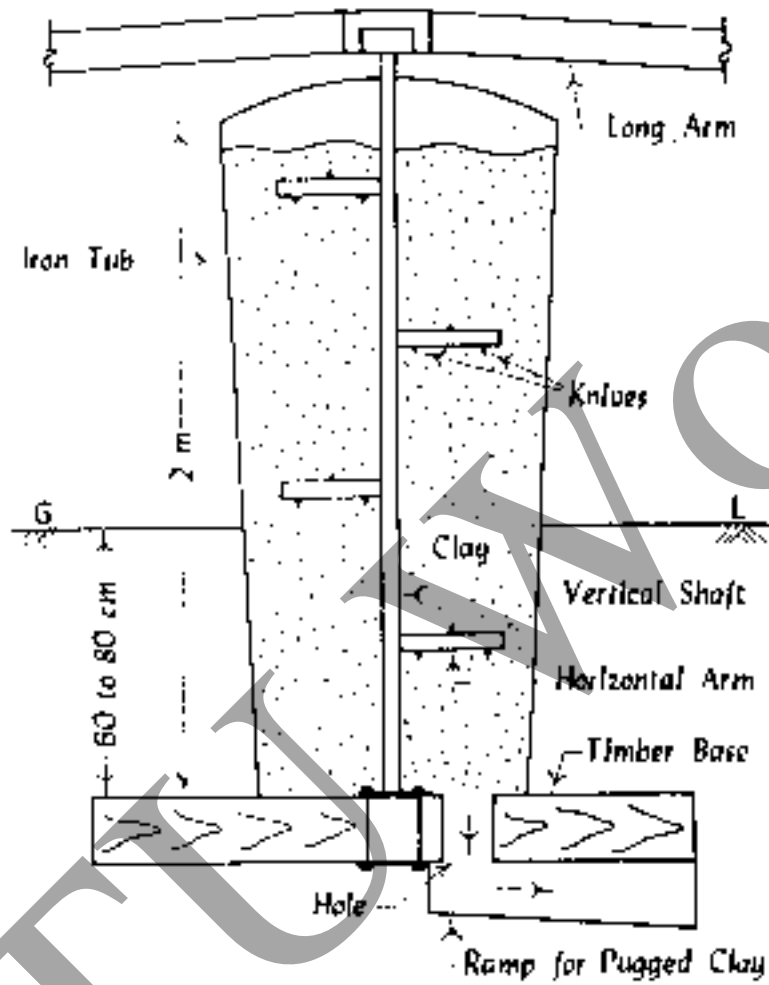

Fig 2.1 Pug Mill

Process:- Clay with water is placed in pug mill from the top. When the vertical staff is rotated by using electric pair, steam or diesel or turned by pair of bullocks. Clay is thoroughly mixed up by the actions of horizontal arms and knives when clay has been sufficiently pugged, hole

at the bottom of tub, is opened cut and the pugged earth is taken out from ramp for the next operation of moulding.

Moulding: Clay, which is prepared form pug mill, is sent for the next operation of moulding. Following are the two ways of moulding.

Hand Moulding: Moulds are rectangular boxes of wood or steel, which are open at top and bottom. Steel moulds are more durable and used for manufacturing bricks on large scale as shown in fig 2.2. Bricks prepared by hand moulding are of two types.

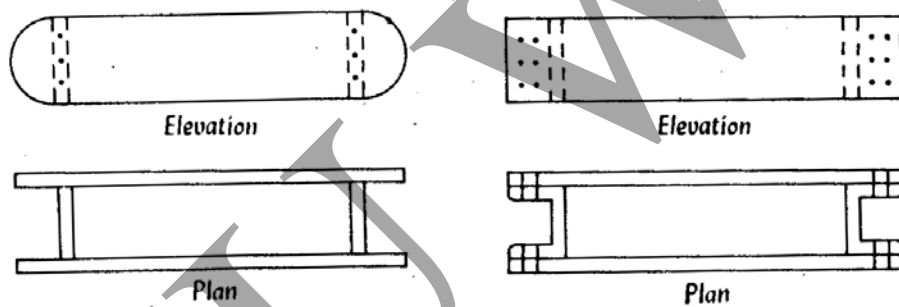

Fig 2.2 Wooden mould & Steel mould

- a) Ground moulded bricks
- b) Table moulded bricks

(a) **Ground moulded bricks:** ground is first made level and fine sand is sprinkled over it. Mould is dipped in water and placed over the ground to fill the clay. Extra clay is removed by wooden or metal strike after the mould is filled forced mould is then lifted up and raw

brick is left on the ground. Mould is then dipped in water every time lower faces of ground moulded bricks are rough and it is not possible to place frog on such bricks.

Ground moulded bricks of better quality and with frogs on their surface are made by using a pair of pallet boards and a wooden block

(b) **Table-moulded bricks:** Process of moulding these bricks is just similar to ground bricks on a table of size about 2m x 1m.

(1) **Machine moulding:** This method proves to be economical when bricks in huge quantity are to be manufactured at the same spot. It is also helpful for moulding hard and strong clay. These machines are broadly classified in two categories

(a) Plastic clay machines

(b) Dry clay machines

a) **Plastic clay machines:** This machine containing rectangular opening of size equal to length and width of a brick. Pugged clay is placed in the machine and as it comes out through the opening, it is cut into strips by wires fixed in frames, so these bricks are called wire cut bricks.

b) **Dry clay machines:** In these machines, strong clay is first converted into powder form and then water is added to form a stiff plastic paste. Such paste is placed in mould and pressed by machine to form hard and well shaped bricks. These bricks are better than ordinary hand

moulded bricks. They carry distinct frogs and exhibit uniform texture.

(2) **Drying:** The damp bricks, if burnt, are likely to be cracked and distorted. Hence moulded bricks are dried before they are taken for the next operation of burning. Bricks are laid along and across the stock in alternate layers. The drying of brick is by the following means

(i) **Artificial drying** – drying by tunnels usually 120°C about 1 to 3 days

(ii) **Circulation of air-** Stacks are arranged in such a way that sufficient air space is left between them free circulation of air.

(iii) **Drying yard-** special yards should be prepared slightly higher level prevent the accumulation of rain water

(iv) **Period for drying** – usually about 3 to 10 days to bricks to become dry

(v) **Screens** – screens are necessary, may be provided to avoid direct exposure to wind or sun.

(3) **Burning:** This is very important operation in the manufacturing of bricks to impart hardness, strength and makes them dense and durable. Burning of bricks is done either in clamps or in kilns. Clamps are temporary structures and they are adopted to manufacture

bricks on small scale. Kilns are permanent structures and they are adopted to manufacture bricks on a large scale. A typical clamp is as shown in fig 2.3

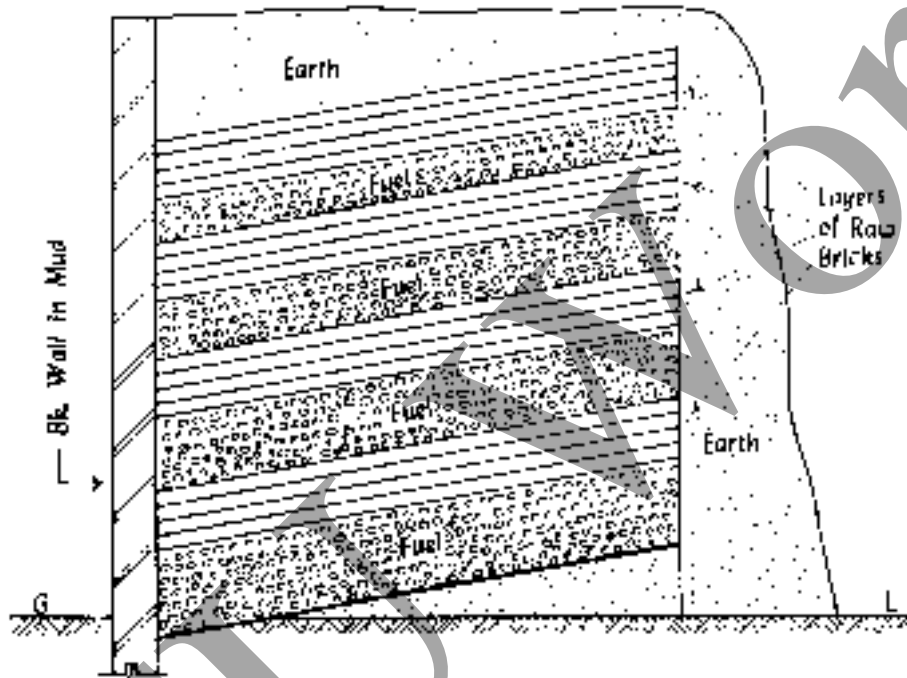

Fig 2.3 Clamp

- (1) A trapezoidal shape in plan with shorter is slightly in excavation and wider end raised at an angle of 15° from ground level
- (2) A brick wall with mud is constructed on the short end and a layer of 70cm to 80cm thick fuel (grass, cow dung, ground nuts, wood or coal) laid on the floor.

- (3) A layer consists of 4 or 5 courses of raw bricks laid on edges with small spaces between them for circulation of air
- (4) A second layer of fuel is then placed, and over it another layer of raw bricks is put up. The total height of clamp in alternate layers of brick is about 3 to 4 m
- (5) When clamp is completely constructed, it is plastered with mud on sides and top and filled with earth to prevent the escape of heat
- (6) The period of burning is about one to two months and allow the same time for cooling
- (7) Burnt bricks are taken out from the clamp

Advantages:

- (i) The bricks produced are tough and strong because burning and cooling are gradual
- (ii) Burning in clamps proves to be cheap and economical
- (iii) No skilled labour and supervision are required for the construction of clamps
- (iv) There is considerable saving of clamps fuel

Bricks

Page 25

Disadvantages:

- (i) Bricks are not of required shape
- (ii) It is very slow process
- (iii) It is not possible to regulate fire in a clamp
- (iv) Quality of brick is not uniform

Kilns: A kiln is a large oven, which is used to burnt bricks by

- 1) Intermittent kilns
- 2) Continuous kilns

1) Intermittent kilns: These intermittent in operation, which means that they are loaded, fired, cooled and unloaded.

- a) Intermittent up-draught kilns
- b) Intermittent down-draught kilns

a) Intermittent up-draught kiln: This is in the form of rectangular with thick outside walls as shown in the fig 2.4. wide doors are provided at each end for loading and unloading of kilns. A temporary roof may be installed to protect from rain and it is removed after kiln is fired. Flues are provided to carry flames or hot gases through the body of kiln.

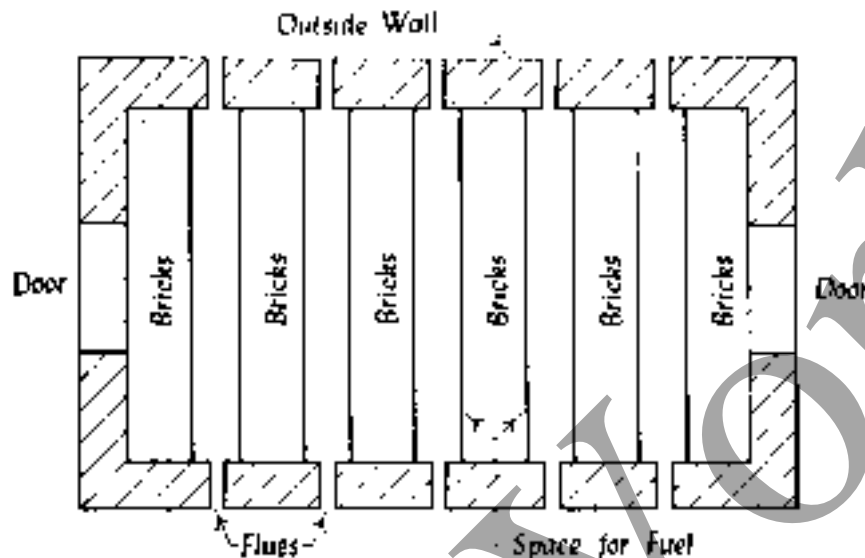

Fig 2.4 Intermittent kiln

- (i) Raw bricks are laid in row of thickness equal to 2 to 3 bricks and height 6 to 8 bricks with 2 bricks spacing between rows
- (ii) Fuels are filled with brush wood which takes up a free easily
- (iii) Loading of kiln with raw bricks with top course is finished with flat bricks and other courses are formed by placing bricks on edges
- (iv) Each door is built up with dry bricks and are covered with mud or clay
- (v) The kiln is then fired for a period of 48 to 60 hours draught rises in the upward direction from bottom of kiln and brings about the burning of bricks.

Bricks

Page 27

- (vi) Kiln is allowed to cool down and bricks are then taken out
- (vi) Same procedure is repeated for the next burning

Bricks manufactured by intermittent up draught kilns are better than those prepared by clamps but bricks burnt by this process is not uniform, supply of bricks is not continuous and wastage of fuel heat.

(b) Intermittent down-draught kilns:

These kilns are rectangular or circular in shape. They are provided with permanent walls and closed tight roof. Floor of the kiln has opening which are connected to a common chimney stack through flues. Working is same as up-draught kiln. But it is so arranged in this kiln that hot gases are carried through vertical flues upto the level of roof and they are then released. These hot gases move down ward by the chimney draught and in doing so, they burn the bricks.

Advantages:

- (i) Bricks are evenly burnt
- (ii) Performance of this kiln is better than that of up-draught kiln
- (iii) This kiln is suitable for burning of structural clay tiles, terra cota because of close control of heat.

2. Continuous kilns:

These kilns are continuous in operations. This means that loading, firing, cooling and unloading are carried out simultaneously in these kilns. There are three types of continuous kilns.

- a) Bull's trench kiln
- b) Hoffman's kiln
- c) Tunnel kiln

a) Bull's trench kiln: This kiln may be of rectangular, circular or oval shape in the plan as shown in fig 2.5. It is constructed in a trench excavated in ground either fully under ground partially projecting above ground openings is provided in the outer walls to act as flue holes. Dampers are in the form of iron plates and they are used to divide the kilns in suitable sections and most widely used kiln in India.

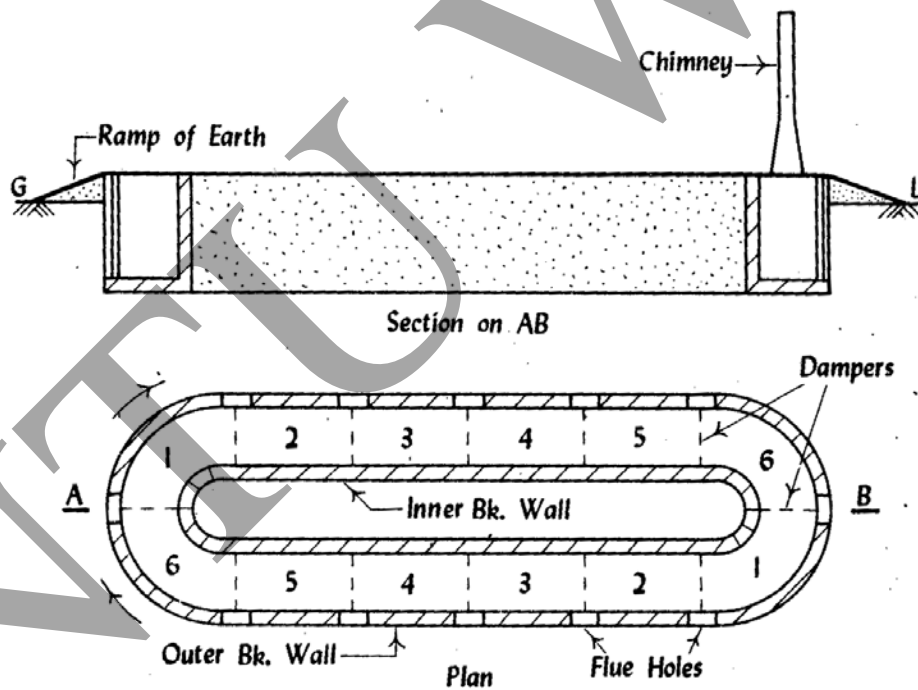

Fig 2.5 Bull's trench kiln

The bricks are arranged in such a way that flues are formed. Fuel is placed in flues and it is ignited through flue holes after covering top surface with earth and ashes to prevent the escape of heat usually two movable iron chimneys are employed to form draught. These chimneys are placed in advance of section being fired. Hence, hot gases leaving the chimney warm up the bricks in next section. Each section requires about one day to burn. The tentative arrangement for different sections may be as follows

Section 1 – loading

Section 2 – empty

Section 3 – unloading

Section 4 – cooling

Section 5 – Burning

Section 6 – Heating

b) Hoffman's kiln: this kiln is constructed over ground and hence, it is sometimes known as flame kiln. Its shape is circular to plan and it is divided into a number of compartments or chambers. A permanent roof is provided; the kiln can even function during rainy season. Fig 2.6 shows plan and section of Hoffman's kiln with 12 chambers

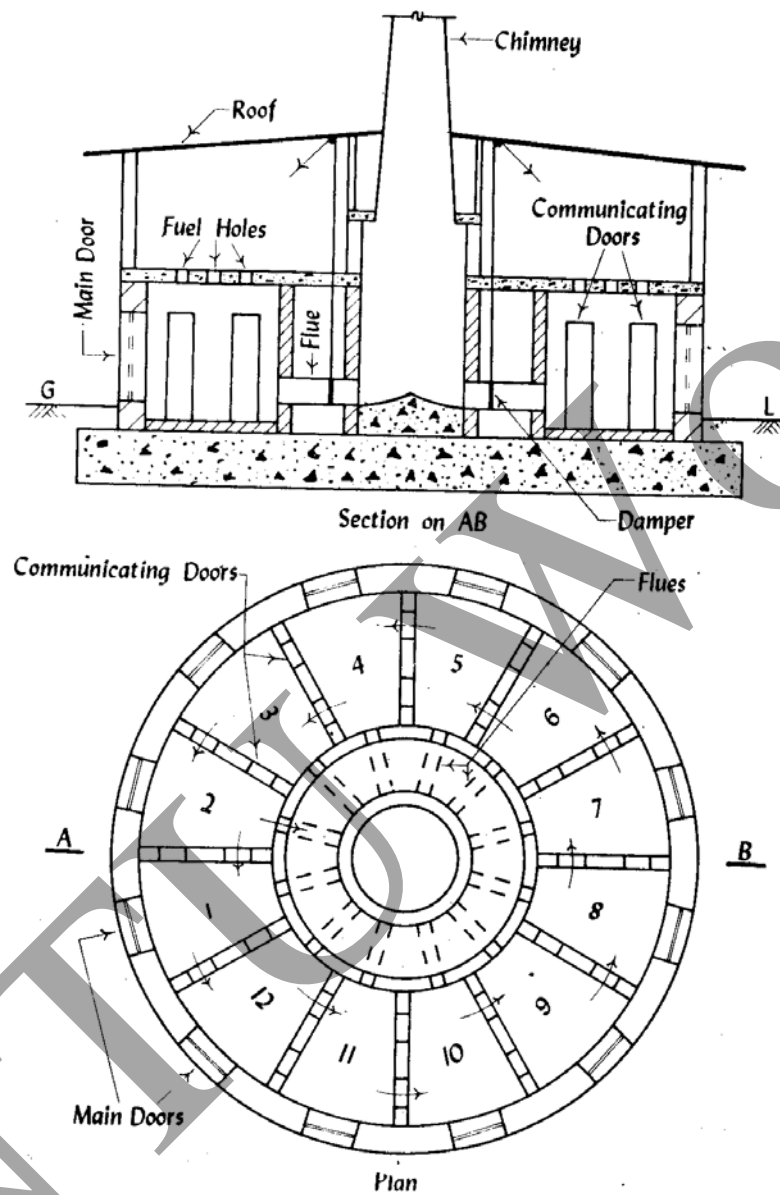

Fig 2.6 Hoffman's kiln

Chamber 1 - loading

Chamber 2 to 5 – drying and pre-heating

Bricks

Page 31

Chambers 6 and 7 - burning

Chambers 8 to 11 - cooling

Chamber 12 – unloading

The initial cost in stalling this kiln is high, the following advantages

- (i) Good quality of bricks are produced
- (ii) It is possible to regulate heat inside the chambers through fuel holes
- (iii) Supply of bricks is continuous and regular
- (iv) There is considerable saving in fuel due to pre heating of raw bricks by flue gases

c) Tunnel kiln: This type of kiln is in the form of tunnel, which may be straight, circular or oval in the plan. Raw bricks are placed in trolleys which are then moved from one end too the other end of tunnel. Raw bricks get dried and pre-heated as they approach zone of fire. In zone of fire, bricks are burnt to the required deque and they are then pushed forward for cooling. When bricks are sufficiently cooled, they are unloaded. The kiln proves to be economical when the bricks are manufactures on a large scale. As temperature is under control, uniform bricks of better quality are produced.

COMPARISON BETWEEN CLAMP-BURNING AND KILN-BURNING

No.	Item	Clamp-burning	Kiln-burning
1.	Capacity	About 20000 to 100000 bricks can be prepared at a time.	Average 25000 bricks can be prepared per day.
2.	Cost of fuel	Low as grass, cow dung, litter, etc. may be used.	Generally high as coal dust is to be used.
3.	Initial cost	Very low as no structures are to be built.	More as permanent structures are to be constructed.
4.	Quality of bricks	Percentage of good quality bricks is small about 60% or so.	Percentage of good quality bricks is more about 90% or so.
5.	Regulation of fire	It is not possible to control or regulate fire during the process of burning.	Fire is under control throughout the process of burning.
6.	Skilled supervision	Not necessary throughout the process of burning.	Continuous skilled supervision is necessary.
7.	Structure	Temporary structure.	Permanent structure.
8.	Suitability	Suitable when bricks are to be manufactured on a small scale and when the demand of bricks is not continuous.	Suitable when bricks are to be manufactured on a large scale and when there is continuous demand of bricks.
9.	Time of burning and cooling.	It requires about 2 to 6 months for burning and cooling of bricks.	Actual time for burning of one chamber is about 24 hours and only about 12 days are required for cooling of bricks.
10.	Wastage of heat.	There is considerable wastage of heat from top and sides and hot flue gas is not properly utilised.	Hot flue gas is used to dry and pre-heat raw bricks. Hence wastage of heat is the least.

2.2 Classification:

Bricks can broadly be divided into two categories.

- (i) Unburnt or sundried bricks
 - (ii) Burnt bricks
- (i) **Un burnt or Sun dried bricks-** UN burn or sun dried with the help of heat received from sun after the process of moulding. These bricks can only be used in the constructions of temporary and cheap structures. Such bricks should not be used at places exposed to heavy rains.
- (ii) **Burnt Bricks:** The bricks used in construction works are burnt bricks and they are classified into the following four categories.
- a. **First Class bricks:** These bricks are table moulded and of standard shape. The surface and edges of the bricks are sharp, square, smooth and straight. They comply with all the qualities of good bricks and are used for superior work of permanent nature.
 - b. **Second class bricks:** These bricks are ground moulded and they are burnt in kilns. The surface of bricks is somewhat rough and shape is also slightly irregular. These bricks are commonly used at places where brick work is to be provided with a coat of plaster.
 - c. **Third class bricks:** These bricks are ground moulded and they are burnt in clamps. These bricks are not hard and they have rough surfaces with irregular and distorted edges.

These bricks give dull sound when struck together. They are used for unimportant and temporary structures and at places where rainfall is not heavy.

- d. **Fourth class bricks:** These are over burnt bricks with irregular shape and dark colour. These bricks are used as aggregate for concrete in foundation, floors, roads, etc because of the fact that the over burnt bricks have compacted structure and hence, they are some times found stronger than even first class bricks.

2.3 Qualities of Good Brick:

- (i) Bricks should be table moulded, well burnt in kilns, copper coloured, free from cracks and with sharp and square edges.
- (ii) Bricks should be uniform shape and should be of standard size.
- (iii) Bricks should give clear ringing sound when struck each other.
- (iv) Bricks when broken should show a bright homogeneous and compact structure free from voids.
- (v) Bricks should not absorb water more than 20 percent by weight for first class bricks and 22 percent by weight for second class bricks, when soaked in coldwater for a period of 24 hours.

- (vi) Bricks should be sufficiently hard no impression, should be left on brick surface, when it is scratched with finger nail.
- (vii) Bricks should be low thermal conductivity and they should be sound proof.
- (viii) Bricks should not break when dropped flat on hard ground from a height of about one meter.
- (ix) Bricks, when soaked in water for 24hours, should not show deposits of white salts when allowed to dry in shade.
- (x) No brick should have crushing strength below 55kg/cm²

2.4 Special Types: Bricks are made in a wide range of shapes and to suit the requirements of the location where they are to be used. Special form of bricks may be needed due to structural consideration or for ornamental decoration as defined by the architect. Specially moulded bricks avoid the cumbersome process of cutting and rounding the rectangular bricks to the desired shape. Some of the special types of bricks commonly used are given below.

- a. **Squint Bricks:** These bricks are made in a variety of shapes and are used to the construction of a cute and obtuse squint quoins as shown in the fig2.7.

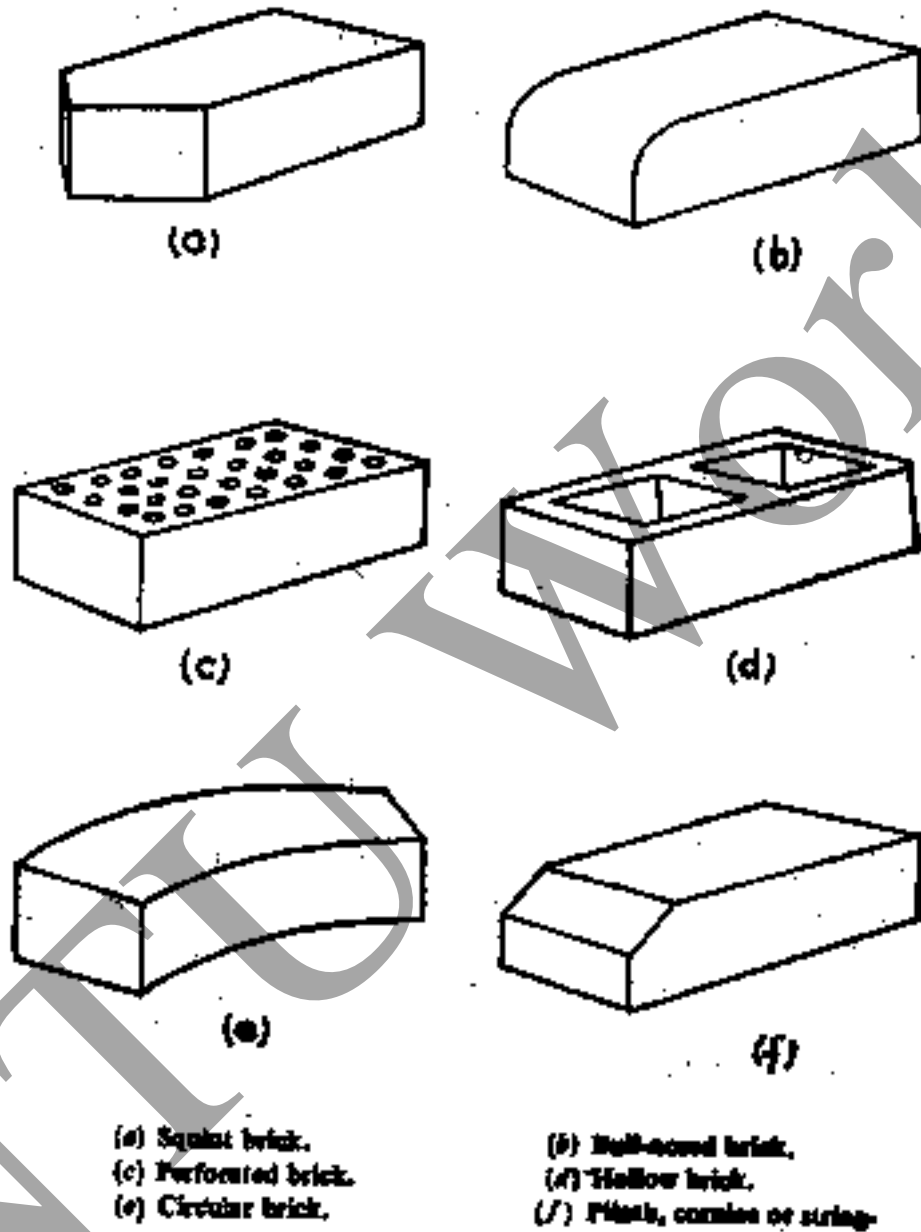

Fig 2.7 Types of Special Bricks

- b. **Bull Nosed Bricks:** These bricks are used to form rounded quoins.

- c. **Perforated Bricks:** These bricks may be standard size bricks produced with perforations running through their thickness. Perforated bricks are easy to burn and their light weight makes it possible to cut down the weight of the structure and effect in foundations. The aperture of the perforations is such that it gives maximum amount of ventilation. But does not permit the entry of rats or mice. These bricks are used for constructing load bearing walls of low buildings, panel walls for multistoried buildings and for providing partition walls.
- d. **Hallow Bricks:** These bricks are made of clay and are provided with one or more cavities. Hallow bricks are light in weight and are used to increase insulation against heat and dampness. They are used for the construction of load bearing walls, partition walls or panel walls to multistoried buildings.
- e. **Circular Bricks:** These bricks have internal and external faces curved to meet the requirement of the particular curve and radius of the wall. These bricks are used for wells, towers etc
- f. **Plinth cornice and String Course Brick:** These bricks are moulded in several patterns with the object of adding architectural beauty to the structure and at the same time to helping to throw the rack water off the face of the walls.
- g. **Coping Bricks:** These bricks are manufactured in a variety of shapes to set the thickness of the wall and are throated on the underside to throw off rain water as shown in the fig2.7

- h. **Paving Bricks:** These bricks are specially made for paving the surface of streets and highways. These bricks are usually made from shale, fire clay or a mixture of the two. They are unaffected by weather and ordinary traffic wear. They are laid on the bed of sand which in turn rests on foundation of stone or concrete. The bricks are laid by grouting with cement mortar or asphalt. They are machine moulded and are burnt in a continuous kiln to ensure high degree of vitrification.

2.5 Tests for bricks :

A brick is generally subjected to following tests to find out its suitability of the construction work.

- ii. Absorption
 - iii. Crushing strength or compression strength
 - iv. Hardness
 - v. Presence soluble salts
 - vi. Shape and size
 - vii. Soundness
 - viii. Structure
- 1) **Absorption:** A good should not absorb not more than 20 percent of weight of dry brick
 - 2) **Compressive strength:** crushing or compressive strength of brick is found out by placing it in compression testing machine. It is pressed till it breaks. Minimum crushing strength of brick is

35kg/cm² and for superior bricks, it may vary from 70 to 140 kg/cm².

- 3) **Hardness:** No impression is left on the surface the brick is treated to be sufficiently hard
- 4) **Presence of soluble salts:** The bricks should not show any grey or white deposits after immersed in water for 24 hours
- 5) **Shape and size:** It should be standard size and shape with sharp edges
- 6) **Soundness:** The brick should give clear ringing sound struck each other
- 7) **Structure:** The structure should be homogeneous, compact and free from any defects

2.6 Grading of Bricks

As per IS10719557 and 1970 code specifications,

- a. Bricks with compressive strength not less than 140kg/cm² – Grade A-A class.
- b. Bricks with compressive strength not less than 105kg/cm² – First class bricks - Grade A.
- c. Bricks with compressive strength not less than 70kg/cm² – Second class bricks – Grade B.
- d. Bricks with compressive strength not less than the average value 35kg/cm² – class III bricks – Grade C.

* * *

SYNOPSIS

1. Brick is a building material composed of following materials

- a. Alumina
- b. Silica
- c. Lime
- d. Oxide of iron
- e. Magnesia

2. The manufacture of bricks is carried out by the following operations

- a. Preparation of clay
- b. Moulding
- c. Drying
- d. burning

3. Bricks are classified as

1. Un-burnt or sun dried bricks
2. Burnt bricks
 - a. First class bricks
 - b. Second class bricks
 - c. Third class bricks
 - d. Fourth class bricks

4. A good brick should

Table moulded, well burnt, uniform shape size, should give clear ringing sound, should be hard, water absorption not more than 20% for 24 hours.

5. The special types of bricks commonly used are

Bricks

Page 41

- a. Squint bricks
 - b. Bult nosed bricks
 - c. Perforated bricks
 - d. Hallow bricks
 - e. Circular bricks
 - f. Coping bricks
 - g. Paving bricks
6. As per IS1077-1957 & 1970
1. Grade A – A class $\leq 140\text{kg/cm}^2$
 2. Second class bricks – grade B $\leq 70\text{kg/cm}^2$
 3. First class bricks – grade A $\leq 105\text{kg/cm}^2$
 4. Class III bricks – grade C average 35kg/cm^2

SHORT ANSWER QUESTIONS

1. What are the constituents of good brick earth?
2. What are the harmful ingredients in brick earth?
3. Name the operations involved in the manufacture of brick.
4. What are the types of bricks?
5. Name the types of special bricks.
6. Name any four uses of bricks.
7. What are the important qualities of brick?
8. What is the use of frog?
9. What are the uses of fire bricks?
10. What are the uses of hollow bricks?
11. What is the size and weight of standard brick?
12. What is meant by blending?
13. What is tempering?

ESSAY TYPE QUESTIONS

1. Explain the manufacturing process of bricks in detail.
2. Explain the classification of bricks.
3. Explain the qualities of bricks.
4. Explain the special types of bricks.
5. Explain the composition of good brick in detail (function of each constituent).
6. Explain the tests to be conducted to a brick.

* * *

CHAPTER -3

CEMENT

Cement in its broadest term means any substance which acts as a binding agent for materials natural cement (Roman Cement) is obtained by burning and crushing the stones containing clay, carbonates of lime and some amount of carbonate of magnesia. The clay content in such stones is about 20 to 40 percent. Natural cement resembles very closely eminent hydraulic lime. It is not strong as artificial cement, so it has limited use in practice.

Artificial cement is obtained by burning at very high temperature a mixture of calcareous and argillaceous materials in correct proportion. Calcined product is known as clinker. A small quantity of gypsum is added to clinker and it is then pulverized into very fine powder is known as cement. Cement was invented by a mason Joseph Aspdin of Leeds in England in 1824. The common variety of artificial cement is known as normal setting cement or ordinary cement or Portland cement.

3.1 Ingredients – Functions

Ordinary Portland cement contains two basic ingredients, namely argillaceous and calcareous. In argillaceous materials, clay predominates and in calcareous materials, calcium carbonate predominates. Good ordinary cement contains following ingredients.

- | | | |
|---------------|-------|-----|
| 1. Lime (cao) | | 62% |
|---------------|-------|-----|

2. silica (SiO_2)	22%
3. Alumina (Al_2O_3)	5%
4. Calcium sulphate (CaSO_4)	4%
5. Iron Oxide (Fe_2O_3)	3%
6. Magnesia (MgO)	2%
7. Sulphur	1%
8. Alkalies	1%

Functions of Ingredients:

1. **Lime:** Lime is the important ingredient of cement and its proportion is to be maintained carefully. Lime in excess makes the cement unsound and causes the cement to expand and disintegrate. On the other hand, if lime is in deficiency the strength of the cement is decreased and it causes cement to set quickly

2. **Silica:** This also an important ingredient of cement and it gives or imparts quick setting property to imparts strength to cement.

3. **Alumina:** This ingredient imparts quick setting properly to cement. Excess alumina weakens the cement.

4. **Calcium Sulphate:** This ingredient is in the form of gypsum and its function is to increase the initial setting time of cement.

5. **Magnesia:** The small amount of this ingredient imparts hardness and colour to cement.

6. **Sulphur:** A very small amount of sulphur is useful in making sound cement. If it is in excess, it causes the cement to become unsound.

7. **Alkalies:** Most of the alkalies present in raw material are carried away by the flue gases during heating and only small quantity will be left. If they are in excess in cement, efflorescence is caused.

3.2 Types of Cement

In addition to ordinary cement, the following are the other varieties of cement.

- a. **Acid Resistance Cement:** This is consists of acid resistance aggregates such as quartz, quartzite's, etc, additive such as sodium fluoro silicate (Na_2SiO_6) and aqueous solution of sodium silicate. This is used for acid-resistant and heat resistant coating of installations of chemical Industry. By adding 0.5 percent of unseed oil or 2 percent of cersil, its resistance to water is increased and known as acid water resistant cement.
- b. **Blast Furnace Cement:** For this cement slag as obtained from blast furnace in the manufacture of pig iron and it contains basic elements of cement, namely alumina, lime and silica. The properties of this cement are more or less the same as those of ordinary cement and prove to be economical as the slag, which is waste product, is used in its manufacture.
- c. **Coloured Cement:** Cement of desired colour may be obtained by intimately mixing mineral pigments with

ordinary cement. The amount of colouring may vary from 5 to 10 percent and strength of cement if it exceeds 10 percent. Chromium oxide gives brown, red or yellow for different proportions. Coloured cements are used for finishing of floors, external surfaces, artificial marble, windows

- d. **Expanding Cement :** This type of cement is produced by adding an expanding medium like sulpho – aluminate and a stabilizing agent to ordinary cement. Hence this cement expands where as other cement shrinks. Expanding cement is used for the construction of water retaining structures and also for repairing the damaged concrete surfaces.
- e. **High alumina Cement:** This cement is produced by grinding clinkers formed by calcining bauxite and lime. The total content should not be less than 32 percent and the ratio by weight of alumina to lime should be between 0.85 and 1.30.

Advantages

1. Initial setting time is about 3 1/2 hours therefore, allows more time for mixing and placing operations.
2. It can stand high temperatures.
3. It evolves great heat during setting therefore not affected by frost.
4. It resists the action of acids in a better way.
5. It sets quickly and attains higher ultimate strength.

Cement

Page 47

Disadvantages:

1. It is costly
2. It cannot be used in mass construction as it evolves great heat and as it sets soon.
3. Extreme care is to taken to see that it does not come in contact with even traces of lime or ordinary cement.

f. **Hydrophobic Cement:** This type of cement contains admixtures, which decreases the wetting ability of cement grains. The usual hydrophobic admixtures are acidol naphthene soap, oxidized petrolatum etc when hydrophobic cement is used, the fire pores in concrete are uniformly distributed and thus the frost resistance and the water resistance of such concrete are considerably increased.

g. **Low Heat Cement:** Considerable heat is produced during the setting action of cement. In order to reduce the amount of heat, this type of cement is used. It contains lower percentage of tri calcium aluminates C_3A and higher percentage of dicalcium silicate C_2S . This type of cement is used for mass concrete works because it processes less compressor strength.

h. **Pozzuolona Cement:** Pozzuolona is a volcanic powder and the percentage should be between 10 to 30.

Advantages

1. It attains compressive strength with age.
2. It can resist action of sulphates.

3. It evolves less heat during setting.
4. It imparts higher degree of water tightness.
5. It imparts plasticity and workability to mortar and concrete prepared from it.
6. It offers great resistance to expansion
7. It possesses higher tensile strength

Disadvantages:

1. Compressive strength in early days is less.
2. It possesses less resistance to erosion and weathering action.

i. Quick Setting Cement: This cement is prepared by adding a small percentage aluminum sulphate which reduce the percentage of gypsum or retarded for setting action and accelerating the setting action of cement. As this cement hardness less than 30 minutes, mixing and placing operations should be completed. This cement is used to lay concrete under static water or running water.

j. Rapid Hardening cement: This cement has same initial and final setting times as that of ordinary cement. But it attains high strength in early days due to

1. Burning at high temperature.
2. Increased lime content in cement composition.
3. Very fine grinding.

Advantages:

1. Construction work may be carried out speedily.

2. Formwork of concrete can be removed earlier.
3. It is light in weight.
4. It is not damaged easily.
5. This cement requires short period of curing.
6. Use of this cement also higher permissible stresses in the design.
7. Structural member constructed with this cement may be loaded earlier.

k. Sulphate Resisting Cement: In this cement percentage of tricalcium aluminates is kept below 5 to 6 percent and it results in the increase in resisting power against sulphate. This cement is used for structure which are likely to be damaged by severe alkaline condition such as canal linings, culverts, siphons etc.

l. White Cement: This is a variety of ordinary cement and it is prepared from such raw materials which are practically free from colouring oxides of Iron, manganese or chromium. For burning of this cement, oil fuel is used instead of coal. It is used for floor finish; plaster work, ornamental works etc.

3.3. Uses of Cement:

1. Cement mortar for masonry work, plaster, pointing etc
2. Concrete for laying floors, roofs and constructing lintels, beams, weather sheds, stairs, pillars etc.

3. Construction of important engineering structure such as bridges, culverts, dams, tunnels storage reservoirs, light houses, deckles etc.
4. Construction of water tanks, wells, tennis courts, septic tanks, lampposts, roads, telephone cabins etc.
5. Making joints for drains, pipes etc.
6. Manufacture of pre cast pipes, piles, garden seats, artificially designed urns, flowerpots, etc dustbins, fencing posts etc.
7. Preparation of foundations, watertight floors, footpaths etc.

3.4. Admixtures – Uses.

These are the ingredients or substance, which are added to concrete to improve its properties like strength, hardness, water resisting power, workability etc. Many admixtures like alum etc are commonly used for this purpose.

* * *

SYNOPSIS

1. Ordinary cement contains

- i) Lime (CaO) - 62%
- ii) Silica (SiO_2) - 22%
- iii) Alumina (Al_2O_3) - 5%
- iv) Calcium Sulphate (CaSO_4) - 4%
- v) Iron Oxide (Fe_2O_3) - 3%
- vi) Magnesia (MgO) - 2%
- vii) Sulphur & Alkalies - 1% each

2. The main types of cements are

- i) Acid resistance cement
- ii) Blast furnace cement
- iii) Coloured cement
- iv) Expanding cement
- v) High alumina cement
- vi) Hydrophobic cement
- vii) Low heat cement
- viii) Pozzolona cement
- ix) Quick setting cement
- x) Rapid hardening cement
- xi) Sulphate resistance cement
- xii) White resistance cement

3. The cement is used for

- i) Masonary work
- ii) Floors, roofs of concrete

- iii) Bridges, culverts, dams, tunnels etc
 - iv) Water tanks, wells , septic tanks, roads, telephone cable etc
 - v) Making joints for drains, pipes
 - vi) Manufacture of pipes, piles etc
 - vii) Preparation of foundation, water tight floors etc.
4. Addition of admixture in cement concrete increases strength, harness, water resisting power, work ability etc.

* * *

SHORT ANSWER QUESTIONS

1. Name the important ingredients of cement
2. Name any four uses of cement
3. What are the important types of cement
4. What are the uses acid-resistant cement?
5. What is use of rapid hardening cement?
6. Explain the following
 - a) Quick setting cement
 - b) white cement
7. What is the use of sulphate resisting cement?
8. What is meant by blast furnace cement?

ESSAY TYPE QUESTIONS

1. Name and explain the ingredients functions in the cement
2. Explain the qualities of cement
3. Explain the varieties of cement
4. Explain the following
 - a) Rapid hardening cement
 - b) High alumina cement
5. Explain in detail the uses of cement

* * *

CHAPTER -4

SAND

Sand is an important building material used in the preparation of mortar, concrete, etc.

4.1 Sources of Sand: Sand particles consist of small grains of silica (SiO_2). It is formed by the decomposition of sand stones due to various effects of weather. The following are the natural sources of sand.

- a. **Pit Sand:** This sand is found as deposits in soil and it is obtained by forming pits to a depth of about 1m to 2m from ground level. Pit sand consists of sharp angular grains, which are free from salts for making mortar, clean pit sand free from organic and clay should only be used.
- b. **Rive Sand:** This sand is obtained from beds of rivers. River sand consists of fine rounded grains. Colour of river sand is almost white. As the river sand is usually available in clean condition, it is widely used for all purposes.
- c. **Sea Sand:** This sand is obtained from sea shores. Sea sand consists of rounded grains in light brown colour. Sea sand consists of salts which attract the moisture from the atmosphere and causes dampness, efflorescence and disintegration of work. Due to all such reasons, sea sand is not recommendable for

engineering works. However be used as a local material after being thoroughly washed to remove the salts.

4.2 Characteristics of sand:

1. It should be chemically inert
2. It should be clean and coarse. It should be free from organic matter.
3. It should contain sharp, angular and durable grains.
4. It should not contain salts, which attract the moisture from atmosphere.
5. It should be well graded (i.e.) should contain particles of various sizes in suitable proportions.

4.3. Grading of Sand:

According to the size of grains, sand is classified as fine, coarse and gravelly

Sand passing through a screen with clear opening of 1.5875mm is known as fine sand. It is generally used for masonry works.

Sand passing through a screen with clear openings of 7.62mm is known as gravelly sand. It is generally used for plastering.

Sand passing through a screen with clear opening of 3.175mm is known as coarse sand. It is generally used for masonry work..

4.4 Bulking of Sand:

The presence of moisture in sand increases the volume of sand. This is due to fact that moisture causes film of water around the sand particles which result in the increase of volume of sand. For a moisture content of 5 to 8 percent, the increase in volume may be about 5 to 8 percent, depending upon the grading of sand. The finer the material, the more will be the increase in volume for a given moisture content. This phenomenon is known as bulking of sand.

When moisture content is increased by adding more water, sand particles pack near each other and the amount of bulking of sand is decreased. Thus the dry sand and the sand completely flooded with water have practically the same volume.

For finding the bulking of sand, a test is carried out with following procedure as in the fig 4.1.

Sand

Page 57

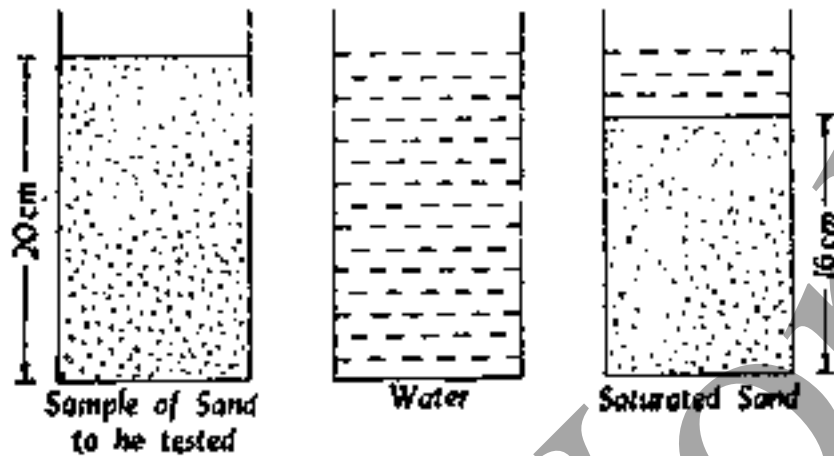

Fig 4.1. Bulking of Sand

- I. A container is taken and it is filled two third with the sample of sand to be tested.
- II. The height is measured, say 20cm.
- III. Sand is taken out of container
- IV. The container is filled with water
- V. Sand is then slowly dropped in the container and it is thoroughly stirred by means of a rod.
- VI. The height of sand is measured say 16cm, then bulking of sand =

$$= \frac{20 - 16}{16} = \frac{4}{16} \quad \text{or } 25\%$$

* * *

SYNOPSIS

1. The sand is important building material used in the preparation of mortar, concrete etc
2. The sources of sand are
 - a. Pit sand
 - b. River sand
 - c. Sea sand
3. The sand should be
 - a. Chemically inert
 - b. Clean and coarse
 - c. Sharp, angular and durable
 - d. Not contain salts
 - e. Well graded
4. According to the size of grains, sand is classified as fine, coarse and gravelly.
5. The presence of moisture in sand increases the volume of sand known as bulking of sand.

Sand

Page 59

SHORT ANSWER QUESTIONS

1. What are the main types of sand according to the natural source?
2. What is meant by bulking of sand?
3. What are the important characteristics of sand?

ESSAY TYPE QUESTIONS

1. Explain the sources of sand.
2. Explain the characteristics of sand.
3. Explain how bulking of sand is found using the experiment.
4. Explain the grading of sand.
5. Explain the bulking of sand.

* * *

CHAPTER 5

MORTAR

The term mortar is used to indicate a paste prepared by adding required quantity of water to a mixture of binding material like cement or Lime and fine aggregates like sand. The two components of mortar namely the binding material and fine aggregates are some times referred to as matrix the durability, quality and strength of mortar will mainly depends on quantity and quality of the matrix. The combined effect of the two components of mortar is that the mass is able to bind the bricks or stones firmly

5.1 Properties – Uses:

The important properties of a good mortar mix are mobility, placeability and water retention. The mobility is used to indicate the consistency of mortar mix, which may range from stiff to fluid

The mobility of mortar depends upon composition of mortar and mortar mixes to be used for masonry work, finishing works, etc are made sufficiently mobile.

The placeability or the ease with which the mortar mix can be placed with minimum cost in a thin and uniform layer over the surface depends on the mobility of mortar. The placeability of mortar mix should be such that a strong bond is developed with the surface of the bed.

A good mortar mix should possess the ability of retaining adequate humidity during the transportation and laying over the porous bed.

If water retention power of mortar mix is low it separates into layers during transportation and when it comes contact with the porous bed like brick, wood, etc, it gives away its water to that surface. Thus the mortar becomes poor in a amount of water and remaining water proves to be insufficient for its hardening. Hence required strength of mortar will not be achieved with such a mortar mix will.

Properties of good mortar

1. It should be capable of developing good adhesion with the building units such as bricks, stones etc.
2. It should be capable of developing the designed stresses.
3. It should be capable of resisting penetration of rainwater.
4. It should be cheap.
5. It should be durable.
6. It should be easily workable.
7. It should not affect the durability of materials with which it comes into contact.

Uses:

1. To bind the building units such as bricks, stones etc.
2. To carry out painting and plaster works on exposed surfaces of masonry
3. To form an even bedding layer for building units

4. To form joints of pipes
5. To improve the appearance of structure.

5.2 Types of Mortar

The mortar are classified on the bases of the following

1. Bulk density
2. Kinds of binding material
3. Nature of application
4. Special mortars

5.2.1 Bulk density:

According to bulk density of mortar in dry state, the mortars are two types

- a. **Heavy mortars** bulk density is more than 1500kg/m^3 and prepared from heavy quartz
- b. **Lightweight mortars** – bulk density is less than 1500kg/m^3 and prepared from light porous sands.

5.2.2. Kinds of binding Material

According to the kinds of binding material, several factors such as expected working conditions, hardening temperature, moisture conditions, etc should be considered. The mortars are classified into four categories.

- a. **Lime Mortar** - in this mortar, lime is used as binding material. Lime may be fat lime or Hydraulic lime. Fat lime mortar 1:2 to 1:3 and hydraulic lime mortar may be 1:2 by VOLUME.

b. **Cement mortar:** In this mortar, cement is used as binding material. Depending upon the strength required and importance of work, the proportion of cement to sand varies from 1:2 to 1:6 or more.

c. **Gauged Mortar or composite mortar:**

The process of adding cement to lime mortar to improve the quality of lime mortar is known as gauging. It makes lime mortar economical, strong and dense. The usual proportion of cement to lime by volume is about 1:6 to 1:8

d. **Gypsum mortar:**

These mortars are prepared from gypsum binding material such as building gypsum and anhydrite binding materials.

5.2.3 Nature of Application:

According to the nature of application, the mortars are classified into two categories.

A. **Brick laying mortars:** Mortars for brick laying are intended to be used for brick works and walls. Depending up on the working conditions and type of construction, the composition of masonry mortars with respect to the kind of binding materials is decided.

B. **Finishing Mortars:** these mortars include common plastering work and mortars for developing architectural or ornamental effects. Generally cement or lime is used as binding material.

5.2.4. Special Mortars:

- A. **Fire resistant mortar**- This mortar is prepared by adding 1:2 ratio of aluminous cement with crushed powder of fire bricks used for fire brick lining furnaces, fire places, ovens etc.
- B. **Light weight mortar** – This mortar is prepared by adding sawdust, wood powder to lime or cement mortar for sound proof and heat proof construction
- C. **Packing Mortar** – To pack of oil wells, special mortars possessing the properties of high homogeneity, water resistance, predetermined setting time, ability to form solid water proof plugs in cracks and voids of rocks, resistance to subsoil water pressure etc. have to be formed with cement sand, cement loam and cement sand loam mortars.
- D. **Sound absorbing mortars**: To reduce the noise level, sound absorbing mortars with Portland cement, lime, gypsum, slag Portland cement etc as the binding materials employed in its composition. The aggregates re selected from lightweight porous material such as pumice, cinders etc.
- E. **X-ray shielding mortar**: This type of mortar is used for providing the plastering coat to walls and ceiling of x-ray cabinets. This is heavy mortar with bulk density over 2200kg/m^3 is used. The aggregates are obtained from heavy rock and suitable admixture are added to enhance protective property of such a mortar.

5.3. Preparation of cement mortar

For preparing mortar, water is added to intimate mixtures of binding material and sand. The water to be used for this purpose should be free from clay, earth and other impurities. Water which is fit for drinking should only be used for preparing mortar.

Cement mortar may be prepared by manual mixing or by mechanical mixing. Mechanical mixing is preferred when mortar is required in large quantities to be used in continuous order.

- a. **Mixing in mechanical mixer:** In this case, cement and sand in desired proportion are fed in the mixer and mixed dry. Water is then added gradually and the wet mixing is continued for at least one minute to obtain the mortar of desired consistency. It is necessary to ensure that only the quantity of mortar which can be used within half an hour of its mixing should be prepared at a time. This is essential as after 30 minutes the mortar begins to set.
- b. **Manual mixing:** In this case, specified quantity of sand is spread and leveled on clean dry masonry platform. Required quantity of cement bags are emptied over the sand layer. The ingredients are then mixed thoroughly by turning them over the sand layer. The ingredients are then mixed thoroughly by turning them over and over. Backward and forward several times with the help of spade. Dry mixing is

continued till the mix have attains a uniform colour. A batch of dry mix is then put in the shallow masonry tank and just sufficient quantity of water is added to bring the mortar to the consistency of a paste. The quantity of dry mix taken in each batch should be such the mortar formed each time is consumed within half an hour.

Precautions in using mortar

1. Consumption of mortar – the consumption of mortar should be as early as possible
Line mortar – with in 36 hours after its preparation
Cement mortar – within 30 minutes
Gaged mortar – within 2 hours.
2. **Frost action** - Setting action of mortar is affected by the presence of frost and not advisable in frosty weather.
3. **Soaking of building units:** Building units should not be soaked before application of mortar. If this precaution is not taken, water of mortar will be absorbed by the building units and mortar will become weak.
4. **Sprinkling of water:** The construction work carried out by mortar should be kept dam or wet by sprinkling water for about 7 to 10 days to avoid rapid drying of mortar.
5. **Workability:** Mortar should not contain excess water and it should be stiff as can be conveniently used. Joints should be well formed and excess mortar from joints should be neatly taken off by a trowel. Surface formed by mortar for building units to rest should be even.

SYNOPSIS

1. The mortar is a paste prepared by adding required quantity of water to a mixture of cement and fine aggregates
2. A good mortar mix should have
 - a. Mobility
 - b. Placeability
 - c. Cheap
 - d. Durable
 - e. Parable
3. The mortar is used for
 - a. to bind bricks, stones
 - b. to plastering
 - c. to form joints
 - d. to improve the appearance
4. The types of mortars
 - a. Lime mortar
 - b. Cement mortar
 - c. Composed mortar
 - d. Gypsum mortar
5. According to nature of application mortars are classified'
 - a. Brick laying mortars
 - b. Finishing mortars
6. The special mortars used generally are
 - a. Fire resistant mortars
 - b. Light weight mortars
 - c. Packing mortars

- d. Sound absorbing mortars
 - e. X-ray shielding mortars
7. The preparation of cement mortar by
- a. Manual mixing – for smaller works
 - b. Mechanical mixing – in larger quantities to be used in continuous order
8. Precautions using mortar are
- a. Consumed within the specified time
 - b. Frosty weather affect the setting time
 - c. Building units should not be soaked before application of mortar
 - d. Apply sprinkling of water for a period of 7 to 10 days
 - e. Mortar should not contain excess water and should be stiff as can be conveniently used.

Mortar

Page 69

SHORT ANSWER QUESTIONS

1. Define mortar.
2. What are the important properties of mortar?
3. Write any four important uses of mortar.
4. Name the types of mortar.
5. What are the precautions to be taken while preparing a cement mortar?

ESSAY TYPE QUESTIONS

1. Explain the properties of mortar.
2. Explain the procedure for preparation of mortar.
3. Write all the uses of mortar.

* * *

CHAPTER-6

CONCRETE

Cement concrete is a mixture of cement, sand, pebbles or crushed rock and water. When placed in the skeleton of forms and allowed to cure, becomes hard like a stone. Cement concrete is important building material because of the following reasons.

1. It can be moulded into any size and shape of durable structural member.
2. It is possible to control the properties of cement concrete.
3. It is possible to mechanise completely its preparation and placing processes.
4. It possesses adequate plasticity for mechanical working.

The cement concrete has the following properties

1. It has high compressive strength
2. It is free from corrosion
3. It hardens with age and continues for a long time after concrete has attained sufficient strength
4. It is proved to be economical than steel
5. It binds rapidly with steel and it is weak in tension, steel reinforcement is placed in cement concrete at suitable places to take up tensile concrete or simply R.C.C.
6. It forms a hard surface, capable of resisting abrasion stresses. This is called reinforced cement.

7. It has tendency to be porous to avoid this proper grading & consolidation of the aggregates, minimum water-cement ratio should be adopted.

6.1 Constituents - Requirements.

The main constituents of concrete are

- a) **Cement / Lime:** Before introduction of ordinary Portland cement, lime was used as cementing material. At present most of the cement concrete works in the building construction is done with ordinary Portland cement. But other special varieties of cement such as rapid hardening cement, high alumina cement are used under certain circumstances. The cement should comply with all standard specifications
- b) **Fine Aggregates:** The material, which is passed through 4.7625mm B.S.test sieve, is termed as fine aggregates. Usually natural river sand is used as fine aggregates. But places where natural sand is not available economically, finely crushed stone may be used as fine aggregates.
- c) **Coarse Aggregates:** The material retained on 4.7625mm size B.S.test sieve is termed as coarse aggregates. Broken stone is generally used as coarse aggregates. For thin slabs, and walls, the maximum size of coarse aggregates should be limited to one third the thickness of the concrete section
- d) **Water:** Water to be used in the concrete work should have the following properties.
 - 1) It should be free from oils

- 2) It should be free from acids or alkalis
- 3) It should be free from Iron, Vegetables matter or other substance, which is likely to have adverse effect on concrete.
- 4) It should be fit for drinking purpose

Function of Water

1. It acts as lubricant for fine and coarse aggregates.
2. It acts chemically with cement to form binding paste with coarse aggregates and reinforcement.
3. It is necessary to flux the cementing material over the surface of the aggregates.
4. It is employed to damp the concrete in order to prevent them absorbing water vitally necessary for chemical action
5. It enables the concrete mix to blow into moulds.

6.2. Uses and types

Uses of Concrete:

1:2:2 - For heavy loaded R.C.C columns and R.C.C arches of long spans

1:2:2 - For small pre cast members of concrete like fencing poles, telegraph poles etc. watertight construction.

1:2:3 - For water tanks, bridges, sewers etc.

1:2½:3½ - For foot path, concrete roads

Concrete

Page 73

1:2:4 - For general work of RCC such as stairs, beams, columns, slabs, etc

1:4:8 /
1:5:10 } For mass concrete for heavy walls, foundation footings etc.

6.3 Preparation of concrete mix:

There are two types of concrete mixing

- (i) Hand mixing
- (ii) Machine mixing

1. Hand Mixing: This method of mixing concrete is resorted to when the quantity of concrete to be used in a work is insufficient to warrant the necessity of machine. This is used with advantage in places where machinery cannot be used on account of their non-availability or in works near a hospital where the noise of machine is not desirable. Hand mixing is done on a clean, hard and impermeable surface. Cement and sand are first mixed dry with the help of shovels until the mixture attains a uniform colour. Aggregative are then added to this mixture and the whole mixture is then turned by shovels until the stone pieces uniformly spread throughout. After this, desired quantity of water is poured into the heap from a can fitted with a rose. The mass is then turned until a workable mixture is obtained. It is advised to add 10% extra cement to guard against the possibility of inadequate mixing by this method.

2. Machine Mixing: - The machine used for mixing concrete is termed as concrete mixer. Two types of concrete mixers are in common are

1. Continuous mixers
2. Batch mixers

Continuous mixers are employed in massive construction where large and continuous flow of concrete is desired. The process of feeding the mixing is more or less automatic. The machine requires careful supervision so as to obtain the concrete mix of desired consistency.

In batch type of concrete mixer. The desired proportion of materials are fed into the hopper of a drum in which the materials get mixed by the series of blades or baffles inside the mixer. Batch mixers are further two types 1. Tilting drum type 2. closed drum type. In the first type, components are fed in the revolving drum in a tilted position and after sometime the concrete mix is discharged by tilting the drums in the opposite direction. In the latter type the drum remains rotating in one direction and emptied by means of hopper which tilts to receive the discharge.

While using the mixer, coarse aggregates should be fed first, sand and cement should be put afterwards. In this revolving state, the components get mixed while water is poured with the help of can. The concrete should be for atleast 2 minutes, the time being measured after all the ingredients including water have been fed into the drum. The batch type concrete mixer is as shown in the fig 6.1.

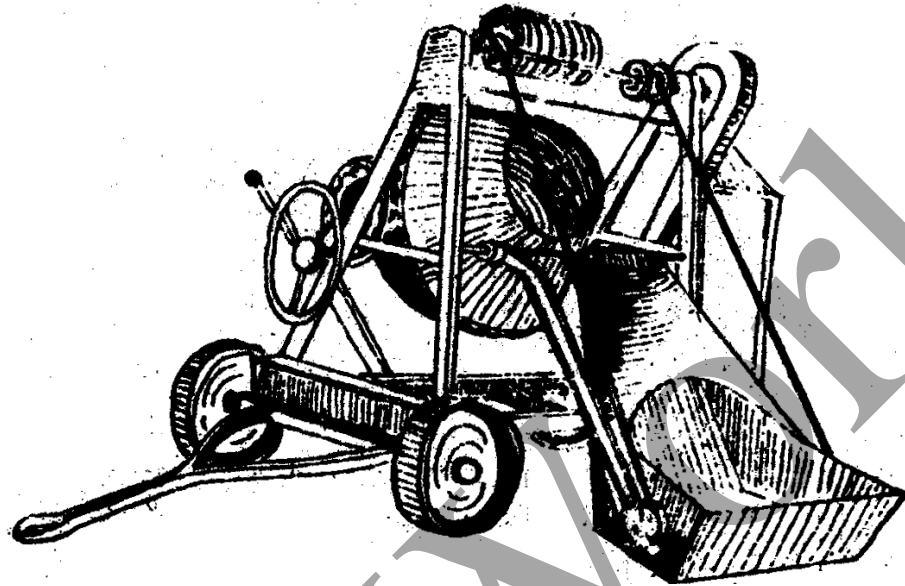

Fig 6.1 Batch type Concrete Mixer

6.4 Compaction - Methods:

Concrete should be placed and compacted immediately after mixing. The concrete should be placed within 30 to 40 minutes to prevent the danger of concrete getting its initial set, before laying the concrete, the shuttering should be cleaned of all of dust or debris. Crude oil or grease etc is usually applied to the shuttering before concreting to prevent the shuttering absorbing the water from the concrete or getting stuck to it. In placing the concrete, care should be taken to see that it should not be thrown from heights. Concrete should be laid in layers 15 to 30 cm (6" to 12") in thickness and each layer should be properly compacted before laying the next one.

Compaction of concrete should be proceed immediately after placing. The function of compaction of concrete is to expel the air bubbles in the mass and make it impermeable in addition to its securing the desired strength. The concrete mass should be consolidated or compacted till the cream of the cement starts appearing on the surface. Over compaction may lead to segregation of concrete while-under-compaction may leave air voids in concrete and results in honey combing. Compaction may be done by hand or mechanical device.

- (i) **Hand compaction:** The hand compaction may be done by rodding, tamping or hammering. Tamping is usually adopted for compacting concrete for slabs or other such surfaces. Rodding is done for thin vertical members. Hammering is done for massive plain concrete works and for compacting an almost dry concrete the surface is beaten with heavy flat bottom rammers till the thin film of mortar start appearing on the surface.
- (ii) **Mechanical compaction:** Mechanical compaction is done by the use of vibrators. Vibrators are of three types 1. Internal 2. External 3. Surface. Internal vibrators are commonly used in large works for flat surface compaction. In this the vibrator is immersed in the full depth of concrete layer. The vibrator should be kept in one position for about 3 minutes and then removed and placed another position. External

vibrators are placed against the form work and are only adopted for thin section of members or in places where internal vibrators cannot be used with ease. Surface vibrators are generally employed in concrete road construction. Compaction of concrete by use of vibrators permits the use of stiff concrete mix of high strength and ensure better compaction than that obtained by the method of hand compaction

6.5 Curing of concrete:

Curing of concrete is one of the essential requirement of process of concreting. Curing is process of keep the set concrete damp for some days in order to enable the concrete gain more strength

Purposes:

- (i) Curing protects concrete surfaces from sun and wind
- (ii) Presence of water is essential to cause the chemical action which a companies the setting of concrete

* * *

SYNOPSIS

1. Concrete is a mixture of cement, sand, pebbles or crushed rock and water
2. Concrete is used for
 - i) Heavy loaded RCC columns, arches etc
 - ii) Pre-cast members
 - iii) Water tanks, bridges, sewers etc
 - iv) Foot path, concrete roads etc
 - v) Foundation footings
3. The preparation of concrete may be
 - i) By hand mixing
 - ii) Machine mixing
4. Machine mixing may be carried out commonly by
 - i) Continuous mixers
 - ii) Batch mixers
5. The function of consolidation or compaction is to expel the air bubbles in the mass and make it impermeable in addition to its securing desired depth
6. Compaction may be done by
 - i) rodding – vertical members like columns
 - ii) tamping – slabs
 - iii) hammering – massive plain concrete works
7. Mechanical compaction may be done by
 - i) Internal vibrators
 - ii) External vibrations
 - iii) Surface vibrations
8. Curing of concrete is the process of keep the set concrete damp for some days in order to enable the concrete gain more strength
9. By curing the concrete should get
 - i) Strength
 - ii) Durability and impermeability
 - iii) Resistance to abrasion

SHORT ANSWER QUESTIONS

1. What are the ingredients of concrete?
2. What are requirements of materials in concrete
 - a) Cement
 - b) Sand
 - c) C.A.
 - d) Water
3. Write any four important uses of concrete
4. What are the types of concrete?
5. What is meant by compaction?
6. What is the importance of compaction?
7. What is meant by curing?
8. What is use of curing of concrete?

ESSAY TYPE QUESTIONS

1. Explain the requirements of constituents of concrete
2. Write the uses of concrete
3. Explain the preparation of concrete by
 1. Hand mixing
 2. Machine mixing
4. What is meant by curing of concrete? Explain importance of curing.
5. What is compaction of concrete? Explain the importance of compaction.

* * *

CHAPTER 7**TIMBER**

Timber denotes wood, which is suitable for building or carpentry or various other engineering purposes like for construction of doors, windows, roofs, partitions, beams, posts, cupboards, shelves etc

Uses of timber:

- (i) Used in the form of piles, posts, beams, lintels, door/window frames and leaves, roof members etc
- (ii) Used for flooring, ceiling, paneling and construction of partition walls
- (iii) Used for form work for concrete, for the timbering of trenches, centring for arch work, scaffolding, transmission poles and fencing
- (iv) Used in wagon and coach building, marine installations and bridges
- (v) Used in making furniture of agriculture implements, sports goods, musical instruments, well curbs, mortar bodies, carts and carriages, railway sleeps, packing cases etc

7.1 Classification of trees

Depending upon their mode of growth trees may be divided in the following two categories

- (i) **Endogeneous trees** – These trees grow inwards and fibrous mass is seen in their longitudinal sections. Timber from

these trees has very limited engineering applications Ex: bamboo, cane , palm etc

- (ii) **Exogeneous trees:** These increases in bulk by growing outwards and used for engineering purposes.

Exogeneous trees are further sub divided into two groups

a) conifers b) deciduous

a) Conifers or evergreen trees: These trees having pointed, needle like or scale like leaves and yield soft wood

b) Deciduous trees: The trees having flat broad leaves and leaves of those trees fall in autumn and new ones appear in spring season. Timber for engineering purpose is mostly derived from deciduous trees. These trees yield hard wood.

Ex: ash, beach, oak, sal, teak, shishum and walnut

Comparison of softwood and hard wood

S.No.	Item	Soft wood	Hard wood
1.	Annual rings	Distinct	Indistinct
2.	colour	light	dark
3.	fire resistance	poor	more
4.	modullary rays	Indistinct	distinct
5.	Structure	resinous and split easily	non-resinous & close grained
6.	weight	light	heavy
7.	strength	strong for direct Pull & weak for Resisting thrust or shear	equally strong for resisting tension, compr-ession & shear

Structure of tree: From the visibility aspect, the structure of a tree can be divided into two categories

1. Macro structure
2. Micro structure

- I. **Macro structure:** The structure of wood visible to the naked eye or at a small magnification is called macro structure. Fig 7.1 shows the macro structure of exogenous tree.

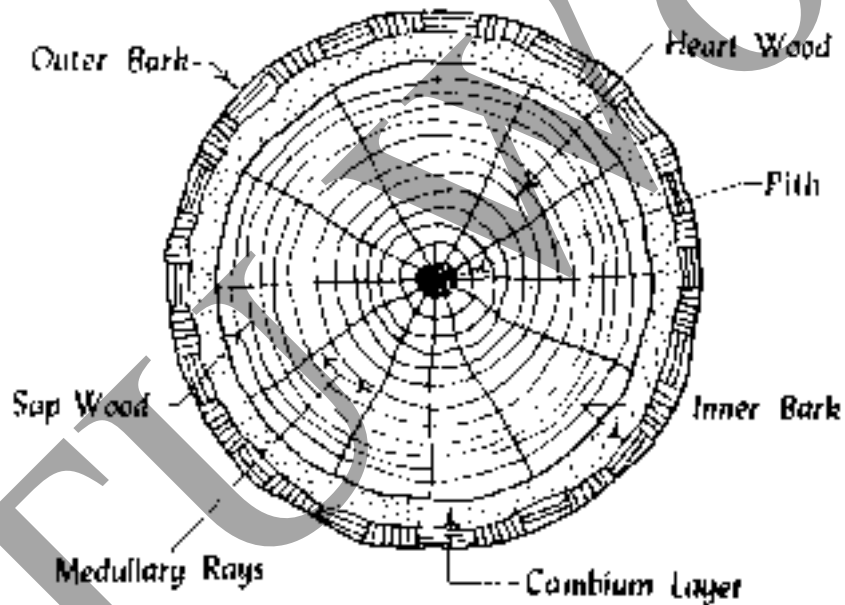

Fig 7.1 Micro structure of exogenous tree

- (i) **Pith:** The innermost central portion or core of the tree is called pith or medulla
- (ii) **Heart wood:** The inner annual rings surrounding the pith is known as heart wood. It imparts rigidity to tree

- (iii) **Sap wood:** The outer annual rings between heart wood and cambium layer is known as sap wood
- (iv) **Cambium layer:** Thin layer of sap between sap wood and inner bark is known as cambium layer
- (v) **Inner bark:** The inner skin or layer covering the cambium layer is known as inner bark
- (vi) **Outer Bark:** The outer skin or cover of the tree is known as outer bark
- (vii) **Medullary rays:** The thin radial fibres extending from pith to cambium layer are known as medullary rays

II. **Micro structure:** The structure of wood apparent only at great magnifications is called micro structure under micro scope, it becomes evident that the wood consists of living and dead cells of various sizes and shapes.

7.2 Defects in Timber:

Defects occurring in timber are grouped into the following divisions.

- a) **Defects due to conversion:** During the process of converting timber to commercial form, the following defects may occur.
 - (i) **Chip mark:** mark or sign placed by chip on finished surface of timber
 - (ii) **Diagonal grain:** Due to improper sawing of timber

- (iii) **Torn grain:** Due to falling of tool small impression is formed
 - (iv) **Wane:** Presence of original rounded surface on the manufactured piece of timber
- b) **Defects due to fungi:** The attack of timber by fungi when moisture content of timber is above 20% and presence of air and warmth for the growth of fungi the following defects are caused
- (i) **Blue stain:** Sap of wood is stained to bluish colour
 - (ii) **Brown rot:** Decay or disease of timber by removal of cellulose compounds from wood and wood assumes the brown colour
 - (iii) **Dry rot:** Convert the wood into dry powder form
 - (iv) **Heart rot:** This is formed when branch has come out of a tree and the tree becomes weak and gives out hallow sound when struck with a hammer
 - (v) **Sap stain:** The sap wood loses its colour because of feed on cell contents of sap wood.
 - (vi) **Wet rot:** Caused chemical decomposition of wood of the timber and timber converts to grayish brown powder known as wet rot.
 - (vii) **White rot:** Attack lignin of wood and wood assumes the appearance of white mass

c) Defects due to insects:

(i) **Beetles:** Small insects form holes of size about 2mm diameter and attack sap wood of all species of hard woods. Tunnels are formed in all directions in sapwood by the larvae of these beetles and converted into fine flour like powder. They do not disturb outer cover and looks sound.

(ii) **Marine borers:** These make holes or bore tunnels in wood for taking shelter. The wood attacked by marine borers loses colour and strength

(ii) **Termites:** White ants are very fast in eating away the wood from the core of the cross section. They make tunnels inside in different directions and usually donot disturb the outershell or cover

d) Defects due to natural forces:

The main natural forces responsible for causing defects in timber are abnormal growth and rapture of tissues

(i) **Burls:** Irregular projections appear on the body of timber because of shock at younger age

(ii) **Callus:** Soft tissue or skin which covers the wound of tree.

(iii) **Chemical stain:** Discoloured due to the chemical action caused

(iv) **Coarse grain:** Annual rings are widened, tree grows rapidly hence timber possesses less strength

- (v) **Dead wood:** Timber obtained from dead standing tree
- (vi) **Druxiness:** White decayed spots by fungi
- (vii) **Foxiness:** Due to poor ventilation during storage or by commencement of decay due to over maturity indicated by red or yellow tinge in wood
- (viii) **Knots:** Bases of branches or limbs which are broken or cut off from the tree as shown in the fig 7.2.

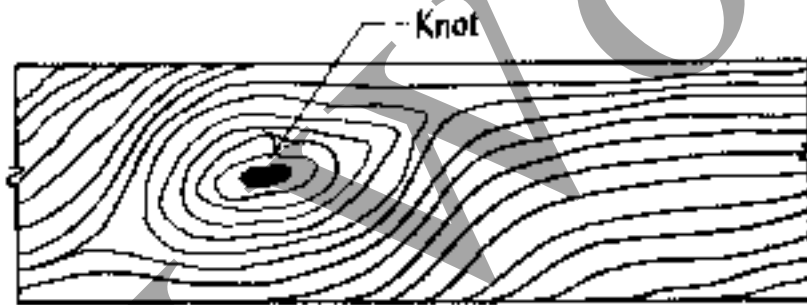

Fig 7.2 Knot

- (ix) **Rind galls:** Rind means bark and gall indicates abnormal growth and peculiar curved swellings found on the body of a tree.
- (x) **Shakes:** These are cracks which partly or completely separate the fibres of wood as shown in fig. 7.3.

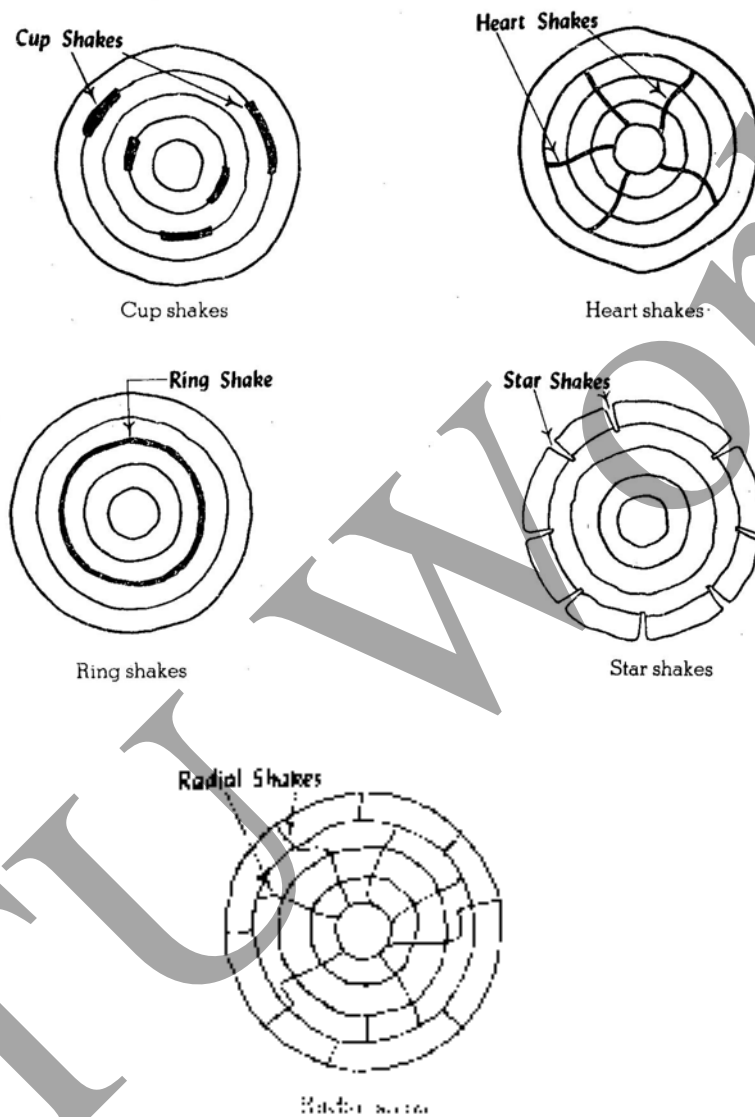

Fig 7.3 Different types of shakes

(xi) **Twisted fibres:** or Wandering hearts: caused by twisting of young trees by fast blowing wind as shown in fig 7.4.

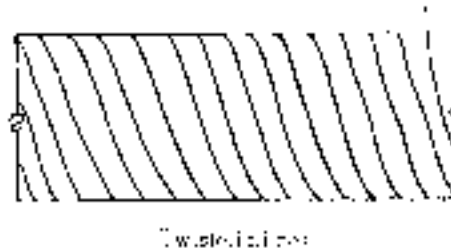

Fig 7.4

- (xii) **Upsets or ruptures:** Indicate wood fibres which are injured by crushing or compression as shown in fig 7.5.

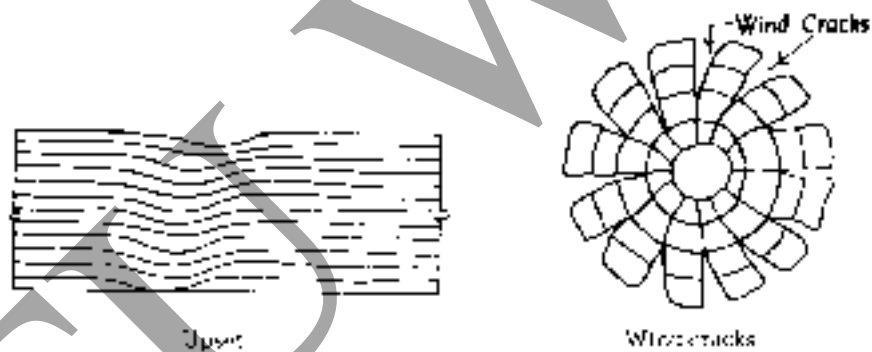

Fig 7.5

7.3 Wood based products:

Timber which is prepared scientifically in a factory is termed as industrial timber and such timber possesses desired shape, appearance strength

- (a) **Veneers:** These are thin sheets or slices of 0.40 to 6mm wood of superior quality. Indian timbers, which are suitable for veneers, are mahogany, oak,

rosewood, sissoo, teak etc. The process of preparing a sheet of veneers is known as veneering. Veneers are used to produce plywoods batten boards and lamin boards.

- (b) **Plywoods:** Plywoods are boards, which are prepared from thin layers of wood or veneers. Three or more veneers in odd number are pressed using adhesives. The plywoods are used for various purposes such as ceilings, doors, furniture, partitions, panelling walls, packing cases, railway coaches, formwork for concrete etc. Thickness may vary from 6 to 25mm.
- (c) **Fibre boards:** These are rigid boards and they are also known as pressed wood or reconstructed wood. The thickness varies from 3mm to 12mm. These are available in lengths from 3 to 4.5m and width varying from 12 to 18m. These are used for
- (i) For internal finish of rooms such as wall panelling; suspended ceilings.
 - (ii) To construct form work for cement concrete.
 - (iii) To construct partitions.
 - (iv) To prepare flush doors, tops of tables etc.
 - (v) To provide an insulating material of heat and sound.
 - (vi) To work as paving or flooring material.

- (d) **Impreg timbers:** Timber which is fully or partially covered with resin is known as impreg timber. The usual resin employed is phenol formaldehyde which is soluble in water. Impreg timber is available under trade names such as formica, sungloss, sunmica etc and it is used for moulds, furniture, decorative articles etc.
- (e) **Compeg timbers:** The process of preparing compeg timbers is same as that of impreg timbers except that curing is carried out under pressure. The strength and durability of compeg timbers is more as compared to the impreg timbers.

7.4. Characteristics of good timbers:

1. **Appearance:** A freshly cut surface of timber should exhibit hard and of shining appearance.
2. **Colour:** A colour should preferably be dark
3. **Defects:** A good timber should be free from series defects such as knots, flaws, shakes etc
4. **Durability:** A good timber should be durable and capable of resisting the action of fungi, insects, chemicals, physical agencies, and mechanical agencies.
5. **Elasticity:** The timber returns to its original shape when load causing its deformation is removed
6. **Fibres:** The timber should have straight fibres

7. **Fire resistance:** A dense wood offers good resistance to fire
8. **Hardness:** A good timber should be hard
9. **Mechanical wear:** A good timber should not deteriorate easily due to mechanical wear or abrasion
10. **Shape:** A good timber should be capable of retaining its shape during conversion or seasoning
11. **Smell:** A good timber should have sweet smell. Unpleasant smell indicates decayed timber
12. **Sound :** A good timber should give a clear ringing sound when struck
13. **Strength:** A good timber should be sufficiently strong for working as structural member such as joist, beam, rafter etc.
14. **Structure:** The structure should be uniform
15. **Toughness:** A good timber should be tough (i.e.) capable of offering resistance to shocks due to vibration
16. **Water permeability:** A good timber should have low water permeability, which is measured by the quantity of water filtered through unit surface area of specimen of wood.
17. **Weathering effects:** A good timber should be able to stand reasonably the weathering effects (dry & wet)
18. **Weight:** The timber with heavy weight is considered to be sound and strong.
19. **Working conditions:** Timber should be easily workable. It should not clog the teeth of saw.

SYNOPSIS

1. Timber is building material used for the construction of doors, windows, roofs, partitions, beams, cupboards etc.
2. The classification of trees depending upon their mode of growth
 - i) Endogeneous trees-bamboo, can, palma
 - ii) Exogeneous trees-
 - a. Confers deodar, keel, cher, fir, pine, spruce, ledar etc
 - b. Deceduous trees-ash, beach, oak, sal, teak, shishum and wallnut
3. From the visibility aspect the structure of a tree can be divided into two categories
 - i) Macro structure
 - ii) Micro structure
4. The defects occurring in a timber are classified into
 - i) Defects due to conversion chip mark, diagonal grain, torn gain, wane
 - ii) Defects due to fungi, blue shain, brown rot, dry rot, heart rot, sap stain, wet rot, white rot etc
 - iii) Defects due to insects beetles, marine borers, termites etc
 - iv) Defects due to natural forces burls, callus, chemical stain, coarse grain, dead wood, druxenous, knots, shakes etc
5. The wood based products are
 - i) Veneers

Timber

Page 93

- ii) Plywood
 - iii) Fibre boards
 - iv) Impreg timbers
 - v) Compreg timbers
6. A good timber should have
- i) Shinning appearance
 - ii) Dark colour
 - iii) Free from defects
 - iv) Durable to action of fungi, insects, chemicals etc
 - v) Fire resistance
 - vi) Should hard
 - vii) Mechanical wear
 - viii) Sweet smell
 - ix) Should give char ringing sound
 - x) Structure should be uniform
 - xi) Should have low water permeability

* * *

SHORT ANSWER QUESTIONS

1. Give the examples to the exogenous trees
2. Give the examples to the endogeneous tress
3. Define the following a) pith b) heart wood
4. Name any four defects in timber
5. What are the important qualities of timber?
6. Name any four wood based products
7. What is plywood?
8. What is meant by seasoning?

ESSAY TYPE QUESTIONS

1. Explain the classification of trees.
2. Explain different defects in timber
3. What are the important qualities of timber and explain.
4. Explain the wood based products
5. What are the advantages of plywoods?

* * *

CHAPTER 8

MISLANEOUS BUILDINGS MATERIALS

8.1 **Metals:** Metals are employed for various engineering purposes such as structural members, roofing materials, damp proof courses, pipes, tanks, doors, windows etc out of all the metals, iron is the most popular metal and it has been used in construction activity since pre-historic times. For the purpose of study metals are grouped in the following two categories

(i) **Ferrous metals:** Ferrous metals contain iron as their main constituent

Ex: Cast iron, wrought iron, steel

(ii) **Non-ferrous metal:** Non ferrous metal does not contain iron as their main constituent

Ex: Aluminium, copper etc

Important varieties of iron ores:

The following are the important commercial varieties of iron ores, which are commonly used, in the manufacturing process

- (1) Haematite – Red oxide of iron (Fe_2O_3) 65 to 70% of iron
- (2) Limonite – $2\text{Fe}_2\text{O}_3, 3\text{H}_2\text{O}$ (60% of iron)
- (3) Magnetite – Fe_3O_4 (70 to 73% of iron)
- (4) Pyrite – FeS_2 (45 to 47% of iron)
- (5) Siderite – FeCO_3 (40% of iron)

8.1.1 **Pig Iron:** The crude impure iron, which is extracted from iron ores, is known as pig-iron and it forms the basic material for the manufacture of cast-iron, wrought iron and steel.

The pig iron is manufactured by the following operations

- (i) **Dressing:** Crushed into pieces 25mm, impurities of clay, loam and other earthy matter removed by washing, magnetic separators are used for magnetic impurities
- (ii) **Calcination and roasting:** Water and carbon dioxide are removing from ores by calcinations. By roasting, making the ores hot and very dry after removal of sulphur
- (iii) **Smelting:** smelting is carried out in a special type furnace known as blast furnace. The raw material consists of iron ores, the fluxing materials like limestone and fuel like coal, charcoal is allowed to through throat portion of the furnace. By the reduction, the pig iron collects in the hearth of furnace. The slag formed is removed and hot gases dust escapes through outlet, which is provided in the throat portion of furnace as shown in fig 8.1.

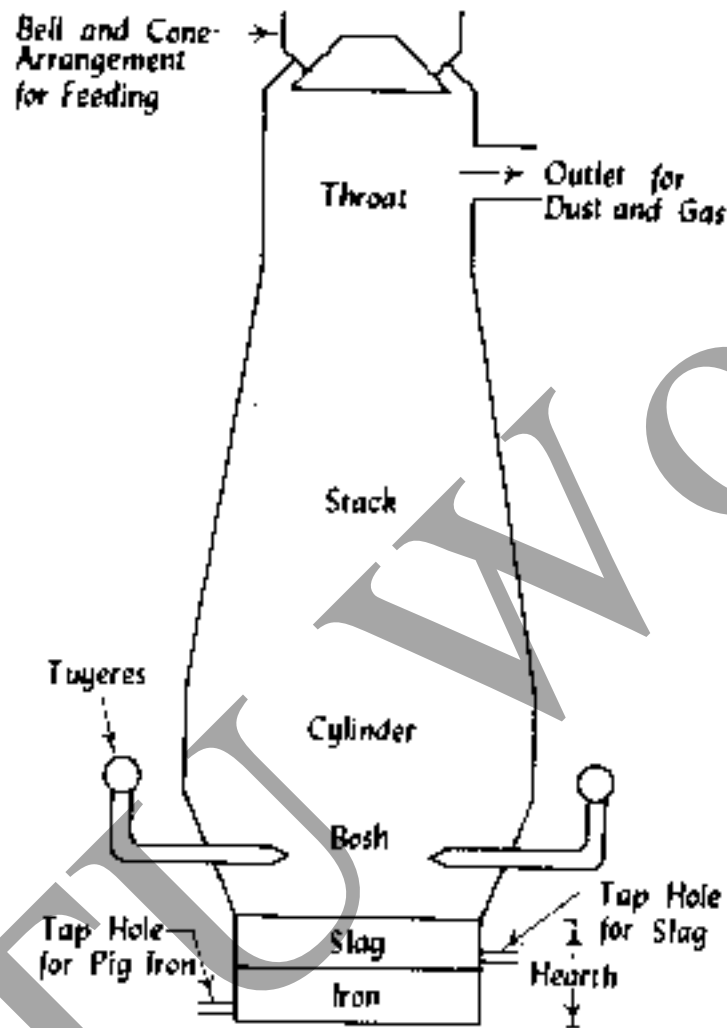

Fig 8.1 Blast Furnace

8.1.2 Cast iron:

Cast iron is manufactured by remelting pig iron with coke and limestone. This remelting is done in a furnace known as cupola furnace, which is more or less same as blast furnace. Its shape is cylindrical with diameter about 1m and height of about 5m as

shown in fig 8.2. The raw materials are led from the top and the furnace is fired. The impurities of pig iron are removed to some extent by oxidation. The molten cast iron is led into moulds of required shapes to form what are known as cast iron castings and slag is removed from the top of cast iron at regular intervals.

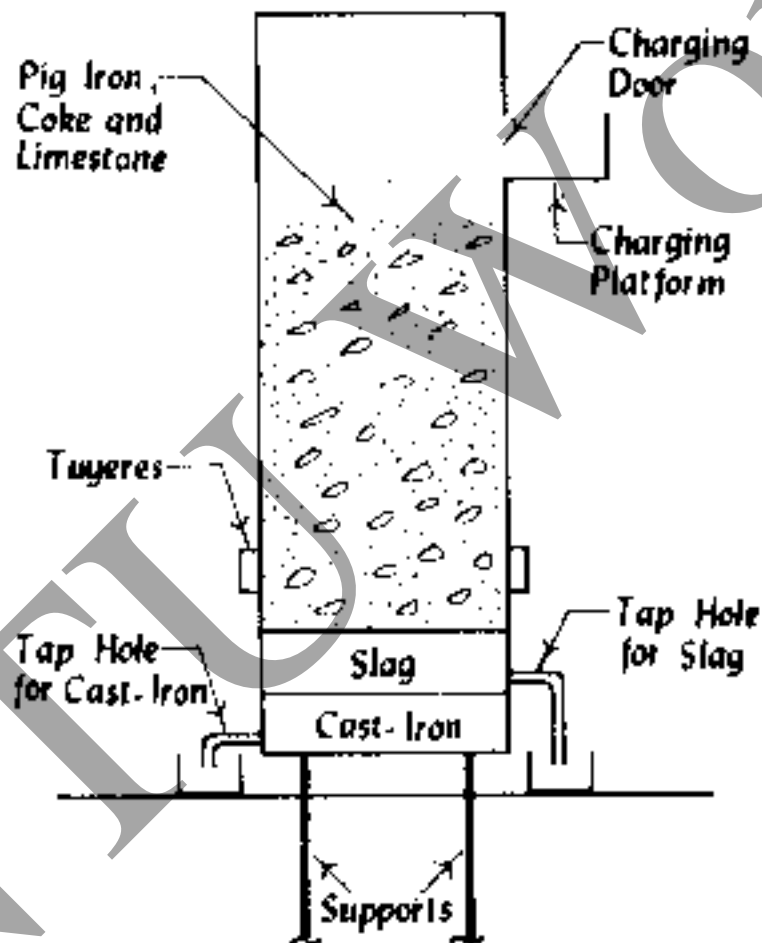

Fig 8.2 Cupola Furnace

Composition of cast iron:

- (1) Cast iron contains about 2 to 4 percent of carbon.
- (2) Manganese makes cast iron brittle and hard, so it may be kept below 0.75 percent.
- (3) Phosphorous makes brittle and percentage may be 1 to 1.5 percent.
- (4) Silicon decreases shrinkage and ensures softer and better castings and it may be less than 2.5 percent.
- (5) Sulphur makes cast iron brittle and hard and should be kept below 0.10 percent.

Properties of cast-iron:

- (1) If placed in salt water, it becomes soft.
- (2) It can be hardened by heating and sudden cooling.
- (3) It cannot be magnetized.
- (4) It does not rust easily.
- (5) It is fusible.
- (6) It is hard, but brittle also.
- (7) It is not ductile and cannot be adopted to absorb shocks and impacts.
- (8) Melting temperature is about 1250°C .
- (9) It shrinks on cooling.

Page 100**Building Materials & Construction**

- (10) Its structure is granular and crystalline with whitish or grayish tinge.
- (11) Its specific gravity is 7.5.
- (12) It lacks plasticity and hence it is unsuitable for forging work.
- (13) It is weak in tension (1500kg/cm^2) and strong in compression (6000kg/cm^2).
- (14) Two pieces of C.I. cannot be connected by the process of riveting or welding (They are to be connected by nuts and bolts).

Uses cast iron:

- (1) For making cisterns, water pipes, gas pipes and sewers, manhole covers and sanitary fittings.
- (2) For making ornamental castings like brackets, gates, lampposts etc.
- (3) For making parts of machinery which are not subjected to shock loads.
- (4) For manufacture of compression members.
- (5) For preparing rail chairs, carriage wheels etc.

8.1.3 **Wrought Iron:** Wrought iron is almost pure and it hardly contains carbon more than 0.15 percent. But the process of its manufacture is laborious and tedious. Wrought iron is manufactured by four operations

Miscellaneous Buildings Materials

Page 101

- a. Refining
- b. Pudding
- c. Shinging
- d. Rolling

Properties of wrought iron:

- 1) It can be easily forged and welded
- 2) It can be used to form temporary magnets
- 3) It is ductile, melleable and tough
- 4) It is moderately elastic
- 5) It is unaffected by saline water
- 6) It resists corrosion in a better way
- 7) Its melting point is about 1500°C
- 8) Its specific gravity is about 7.8
- 9) Its ultimate compressive strength is about 2000 kg/cm^2
- 10) Its ultimate tensile strength is about 4000 kg/cm^2 .

Uses of wrought iron:

It is used for rivets, chains, ornamental iron work, railway couplings, water and steam pipes, bolts and nuts, horse shoe bars, hand rails, straps for timber roof trusses, boiler tubes, roofing sheets etc.

8.1.4 Steel : As per as carbon content is concerned, steel forms an intermediate stage between cast iron and wrought iron. Cast iron contains carbon from 2 to 4 percent and wrought iron contains 0.15 percent. In steel the carbon content varies from 0.25 to 1.5 percent. The steel is manufactured by the following processes.

- 1) Bessemer process
- 2) Cementation process
- 3) Crucible steel process
- 4) Duplex process
- 5) Electric process
- 6) L.D. Process
- 7) Open-hearth process

Physical properties of steel:

- i) **Carbon content:** Variation in carbon percentage produces steel of different grades. Carbon always assists in increasing the hardness and strength of steel and decreases the ductility of steel.
- ii) **Presence of impurities:**
 - a) Silicon content is about 0.30 to 0.40 percent, elasticity and strength of steel are considerably increased.

- b) Sulphur content between 0.02 to 0.10 percent, no appreciable effect on ductility or strength however malleability and weld ability decreases.
 - c) Phosphorous content below 0.12 percent reduces shock resistance, ductility and strength of steel.
 - d) Manganese content 0.3 to 1.00 percent, the steel becomes very brittle and hence, it loses its structural value
- iii) **Heat treatment processes:** It is possible to alter the properties of steel by heating and cooling under controlled conditions. The following are the purposes of heat treatment
- i) To alter magnetic properties of steel
 - ii) To change the structure of steel
 - iii) To increase resistance to heat and corrosion
 - iv) To increase surface hardness
 - v) To make steel easily workable
 - vi) To vary strength and hardness

The principal processes involved in the heat treatment of steel

- 1) **Annealing-** To make steel soft
- 2) **Case hardening-**The core of specimen remains tough and ductile
- 3) **Cementing-** The skin of the steel is saturated with carbon (880 to 950⁰C)
- 4) **Hardening-** It is reverse process of annealing to make hard

- 5) **Normalising**-To restore steel to normal condition and it is adopted when structure of steel is seriously disturbed for any reason
- 6) **Tempering**-This process is applied to steel, which are treated with hardening process
- iv) **Magnetic properties of steel:** Steel widely used in electrical machinery, generates, transformers etc. For making steel suitable for such use, its magnetic properties are given supreme importance and these properties are obtained by carefully adjusting its chemical composition.
- i) **Carbon** – carbon content as low as possible and should not exceed 0.10 percent.
 - ii) **Silicon**-presence of silicon results in considerable increase of electrical losses and hence it highly undesirable.
 - iii) **Sulphur and phosphorous:** Combines content of sulphur and phosphorous exceeds 0.3 percent, magnetic properties of steel are greatly affected.
 - iv) **Manganese:** If manganese content exceeds 0.3 percent, it proves to be injurious to the magnetic properties of steel.

Uses of steel:

1. Mild steel	0.10% carbon	Mortar body, sheet metal, tin plates etc
2. Medium carbon steel	0.25% 0.45% 0.60%	Boiler plates, structural steel, rails, tyres etc Hammers, large stamping dies etc
3. High carbon steel	0.75% 0.95% 1.00% 1.10%	Sledge hammers, springs, stamping dies etc Minor drills, smith & tools, Masons tools Chisels, hammers, saws, wood, working tools Axes, cutlery, drills, knives, picks, punches etc.

8.1.5 Non Metals:

I. Aluminium:- Aluminium is important non metal occurs in abundance on the surface of earth in various forms such as oxides, sulphates, silicates, phosphates etc. Bauxite ($\text{Al}_2\text{O}_3 \cdot 2\text{H}_2\text{O}$) is hydrated oxide of aluminium produced commercially.

Aluminum is extracted from bauxite are as follows.

1. Bauxite is purified.
2. It is then dissolved in fused cryolite which is double fluoride of aluminium and sodium, $\text{AlF}_3 \cdot 3\text{NaF}$.

3. This solution is then taken to an electric furnace and aluminium is separated out by electrolysis.

Properties:

1. It is good conductor of heat and electricity
2. It is a silvery white metal with bluish tinge and it exhibits luster on a freshly broken surface.
3. It is rarely attacked by nitric acid, organic acid or water. It is highly resistant to corrosion.
4. It is light in weight, malleable and ductile
5. It is very soft.
6. It melts at about 658°C .
7. It possesses great toughness and tensile strength
8. It readily dissolves in hydrochloric acid
9. Its specific gravity is about 2.70.

Uses:

1. This metal is used for making parts of aeroplane, utensils, paints, electric wires, window frames, glazing bars, corrugated sheets, structural members, focts, posts, panels, balustrades, etc.

II. Copper:

The important ores of copper are cuprite Cu_2O , Copper glance Cu_2S , copper pyrites CuFeS_2 , Malachete CuCo_3 , $\text{Cu}(\text{OH})_2$ and Azurite CuCo_3 , $\text{cu}(\text{OH})_2$.

Properties:

1. It becomes brittle just below its melting point
2. It can be worked in hot or cold condition but it cannot be welded.
3. It has a peculiar red colour

4. It is a good conductor of heat and electricity
5. It is attacked by steam at white heat.
6. It is not attacked by dry air, but moist air gases a green coating to copper surface.
7. It is not attacked by water at any temperature
8. It is melleable, ductile and soft
9. Its specific gravity is 8.90.

Uses:-

1. The market forms of copper are ingots, sheets, tubes and wires.
2. It is extensively used for making electric cables, alloys, household utensils, electroplating, lighting conductors, dowels in stone masonry, etc.

8.2. Plastics:

Plastic is one the recent engineering materials, which has appeared in the market all over the world. Plastic is an organic substance and it consists of natural or synthetic binder or resins with or without moulding compounds. Plastics are the compounds of carbon with other elements such as hydrogen, nitrogen and oxygen.

Properties:

1. **Appearance:** Some Plastics are completely transparent in appearance
2. **Chemical resistance:** Plastics offer great resistance to moisture, chemicals and solvents.

3. **Dimensional Stability:** This property of plastic favours quite satisfactorily with that of other common engineering materials.
4. **Ductility:** Plastic lacks ductility. Hence its member may fail without warning
5. **Electrical Insulation:** Plastic posses excellent electric insulating property
6. **Durability:** Please are quite durable.
7. **Finishing:** Any surface treatment may be given to plastic. It is also easy to have technical control during its manufacture.
8. **Fire Resistance:** Plastic are organic in nature and hence, all plastics are combustible.
9. **Fixing:** Plastics can be easily fixed in position they can be bolted, clamped, drilled, glued, screw threaded or simply push filled in position.
10. **Humidity:** The properties of plastic are governed to some extent by humidity.
11. **Maintenance:** It is easy to maintain plastic surfaces.
12. **Melting Point:** Most of the plastics have low melting point is about 50°C .
13. **Optical Property:** Several types of plastics are transparent and translucent.
14. **Sound Absorption:** Acoustical boards are prepared by impregnating fiberglass with phenolic resins.
15. **Strength:** Plastic are reasonably strong. The strength of plastics may be increased by reinforcing with various fibrous materials.

16. **Thermal property:** Thermal conductivity of plastics is low compared to with wood.
17. **Weather Resistance:** Only certain varieties of plastics can be exposed to weather.
18. **Weight:** Low Specific gravity. The length weight of the plastic reduces the transport costs and facilitates fixing.

Uses of Plastics:

1. Bath and Sink units
2. Cistern ball floats
3. Corrugated and plain sheets
4. Decorative laminate and mouldings
5. Electrical conducts
6. Electrical insulations
7. Films of water proofing, damp proofing
8. Floor tiles
9. Foams for thermal insulation
10. Jiontless flooring
11. Lighting fixtures
12. Overhead water tanks
13. Paints and varnishes
14. Pipes to carry cold water
15. Roof lights
16. Wall tiles
17. Safety glass
18. Water resistant adhesives etc.

8.3. Adhesives:

An adhesive is a substance, which is used to join two or more parts so as to form a single unit.

Advantages:

1. A wide variety of combination is joining is possible
2. It can be used for bonding the surfaces of glass, metal, plastics and wood.
3. It creates a massive effect
4. It is possible to prevent corrosion between different metals joined by adhesive.
5. It produces adequate strength
6. Permeable joint can be made impermeable for water and gas by the application of adhesives
7. The process of applying adhesives is easy, economical and speedy.

Disadvantages

1. It is not possible to adopt any adhesive for all substances.
2. The adhesive substances does not become strong immediately after its application
3. The adhesive substances does not generally remain stable at high temperatures.

8.4 Asbestos:

Asbestos is naturally occurring fibrous mineral substance. It is composed of hydrous silicates of calcium and magnesium

($\text{CaSiO}_3, 3\text{MgSiO}_3$) It also contains small amounts of Iron Oxide and alumina Natural asbestos can be divided into two groups.

1. Acid resistances asbestos.
2. Non Acid resistance asbestos.

Properties:

1. Holes can be drilled and screws can be fitted on its surface.
2. It can be cut into pieces
3. It is an excellent insulator of heat and electricity.
4. It is fire proof and acid proof
5. It is flexible soft and Non-proof
6. It is smooth like glass and silk
7. It possesses a good adsorption capacity
8. Its colour is brown, grey or white
9. Its melting point is 1200C to 1550^0C
10. Its specific gravity is 3.10
11. Its quality is critically affected by the length of fibers
12. Its molecules are strong bound together only in one direction and that is why it possesses very high tensile strength along the fibers.

Uses:

1. Asbestos cement products have become very popular at present
2. Asbestos felt can be prepared by coating asbestos fibers with bitumen and it is used as damp proof layer.
3. It is used as covering material for magnetic coils
4. It is used as lining material of fuse box and switch box
5. It is used for insulating boilers, furnaces, etc.

6. It is used for preparing fire proof cloths, ropes etc
7. It is used to form asbestos paint.

8.5 Glass:

Glass is a mixture of a number of metallic silicates, one of which is usually that of an alkali metal. It is an amorphous, transparent or translucent. It may also be considered as a solidified super cooled solution of various metallic silicates having infinite viscosity. For the purpose of classification glass may be grouped into the following three categories.

1. Soda-lime glass. $\text{Na}_2\text{O}, \text{CaO}, 6\text{SiO}_2$
2. Potash-lime glass. $\text{K}_2\text{O}, \text{CaO}, 6\text{SiO}_2$
3. Potash – Lead glass. $\text{K}_2\text{O}, \text{PbO}, 6\text{SiO}_2$

Properties:-

1. It absorbs, refracts or transmits light.
2. It can take up high polish and may be used as substitute for every costly gem.
3. It has no definite crystalline structure.
4. It has no sharp melting point.
5. It is affected by alkalis
6. It is an excellent electrical insulator
7. It is available in beautiful colours.
8. It behaves more as solid than most solids in the sense that it is elastic
9. It is capable of being worked in many ways
10. It is extremely brittle.
11. It is not usually affected by air or water

12. It is possible to intentionally alter some of its properties such as fusibility, hardness, refractive power or to suit different purposes.
13. It is not easily attacked by ordinary chemical reagents.
14. It is possible to make objects of glass with diversified properties. The glasses may be clear, colourless, diffused and stained.
15. It is possible to weld pieces of glass by fusion
16. It is transparent and translucent.
17. When it is heated, it becomes soft and soft with rise in temperature.
18. It is possible to make glass lighter than cork or softer than cotton or stronger than steel by using advancement of science.

Uses:

- 1. Soda lime glass:** It is used in the manufacture of glass tubes, laboratory apparatus, plate glass, window glass etc.
- 2. Potash lime glass:** It is used in the manufacture of glass articles, which have to withstand high temperatures.
- 3. Potash – Lead glass:** It is used in the manufacture of artificial gems, electric bulbs, lenses, prisms etc.
- 4. Common Glass:** It is mainly used in the manufacture of medicine bottles.

8.6 Plaster of Paris.

When finely ground gypsum rock is heated to a temperature between 100°C and 140°C , three fourth of the combined water passes off as gas stream. The remaining product

is known as 'Plaster of Paris' if pure gypsum has been used and 'Hard wall Plaster' of the gypsum rock contains impurities.

- Uses:**
1. Plaster of Paris is used for cast of nonmetal plasterwork
 2. It produces hard surface, sharp contours.

8.7 Linoleum:

It is a mixture of oxidized unseed oil, pulverized cork, wood flour, pigments and colours, all spread in a uniform layer on canvas the surface of which may be painted in different patterns, the surface is then, afterwards water-proofed with the help of an oil paint.

It is available in different gauges (i.e thickness 6.7, 6.0, 4.5, 3.2, 2.0 and 1.6mm) and is easily cleaned with soap water. It is not affected by oil but slightly affected by acids. Linoleum is made in rolls as well as in tiles. Linoleum is used for floor coverings of hospitals, canteens, residences, offices and industrial buildings.

8.8 Wall paper:

Wall paper are now widely used for developing decorative finished of interior walls and they are made exclusively from paper or combined with other materials. They may be unprimed, primed, embossed, metal-coated etc. They are available in single or multicolour patterns printed on the face surfaces. Varnished wall paper can be polished after hanging to develop the effect of veneer panelled wall. Certain types of wall

papers are washable. Wall paper with sound absorbing properties are also available Metal-coated wall papers are prepared from wall papers coated with a primer of metallic powder and then patterns are printed or embossed in the surface.

8.9 a) Bitumen: Bitumen is the binding material, which is present in asphalt. This is also called tar obtained from partial distillation of crude petroleum

1. It is chemically a hydro-carbon
2. Insoluble in water
3. Soluble in carbon disulphide
4. Black or brown in colour

The following are the forms of bitumen

1. Bitumen emulsion
2. Blow bitumen
3. cut-back bitumen
4. plastic bitumen
5. straight run bitumen

b) Tar: Tar is a dark black liquid with high viscosity. According to its source, tar is classified into following categories

- 1) Coal Tar
- 2) Mineral Tar
- 3) Wood Tar

1) Coal Tar: Usually obtained as a by-product during the manufacture of coal gas. Coal tar is used for making macadam roads, preserving timber etc.

2) Mineral tar: This variety of tar is obtained by distilling bituminous shales. It contains less volatile matter

Page 116

Building Materials & Construction

3) Wood tar: This type of tar is obtained by distillation of pines and similar other resinous trees. It contains creosote oil hence, it possesses strong preservative property.

Uses:

1. Roofing, damp proofing felts
2. Fill cracks in masonry structures, for stopping leakages etc

8.10 Thermocole:

It is used for thermal insulation and sound insulation.

* * *

SYNOPSIS

1. The ferrous metals used for various engineering purposes cast iron, wrought iron and steel
2. The non-ferrous metals which are generally used in engineering structures are Aluminium, cobalt, copper, lead, magnesium, nickel, tin, zinc etc
3. The important ores of iron are hematite, lemonite, magnetite, pyrite and siderite.
4. The manufacture of pig iron involved following operations
 - (i) Dressing
 - (ii) Calcination and roasting
 - (iii) Smelting
5. Cast iron contains 2 to 4 percentage of carbon, wrought iron the carbon content does not exceed 0.15 percent and where as in steel, carbon percentage should be 0.15 to 1.5 percent
6. Aluminium is extracted from bauxite and used for making the parts of aeroplane, utensils, paints, electric wires, window frame, structural members etc.
7. Copper is a non-ferrous metal used for sheets, tubes, wires, cables, alloys, household utensils, electroplating, lightening conductors etc.
8. Plastics are the compounds of carbon with other elements such as hydrogen, oxygen and nitrogen used for the following.
Electrical conducts, insulators, floor tiles, thermal insulation, corrugated and plain sheets, bath and sink units etc

9. Adhesive is a substance used to join two or more parts so as to form single unit have following uses
- (i) To join glass, metal, plastic, wood
10. Asbestors is naturally occurring fibrous mineral substance used for the following
- (i) Damp proof layer
 - (ii) Covering material for magnetic coils
 - (iii) Lining material for fuse box and switch box
 - (iv) Insulating boilers, furnaces etc
 - (v) Fire proof cloths, ropes etc
11. Glass is a mixture of metallic silicates used for the following glass tubes, laboratory apparatus, window glass, artificial gems, electric bulbs, prisms, medicine bottles
12. Plaster of paris is used fro the following purposes
- (i) Ornamental works
 - (ii) Produces hard surface, sharp contours
13. Linoleum is mixture of oxidized unseed oil pulverized cork, wood flour, pigments and colour, all spread in a uniform layer on canvas the surface of which may be painted in different patterns, the surface is then, afterwards water-proofed with the help of an oil paint.

SHORT ANSWER QUESTIONS

1. Name important metals used in building construction
2. Name important non-metals used in the building construction
3. What are the uses of cast iron?
4. What are the uses of wrought iron?
5. What are the properties of steel?
6. Name any four uses of steel.
7. What are the properties of plastics?
8. Name any four uses of plastics.
9. What are the uses of glass?
10. What are the uses of adhesives?
11. Name any four uses of asbestos.
12. What is the use of thermocole?
13. What is the importance of plaster of paris in the building construction industry?
14. Name the uses of linoleum
15. What are the uses of wall paper?
16. Write the uses of bitumen & tar
17. What are the uses of plasticrete?

ESSAY TYPE QUESTIONS

1. Explain the properties and uses of steel
2. Explain the following
 - a. Plastics
 - b. asbestos
3. Explain the properties and uses of cast iron
4. Explain the following
 - a. Plaster of paris
 - b. Linoleum

* * *

CHAPTER – 9

TYPES OF BUILDINGS

9.1 Classification:

According National Building code of India, 1970 the buildings on the basis of occupancy are classified into following groups

GROUP A: Residential buildings:

All those buildings in which sleeping accommodation is provided for residing permanently or temporary with or without cooking or dining or both facilities are termed as residential building

Ex: Apartments, Flats, Bungalows, Dormitories, private houses, Hotels, Hostels, Cottages, Holiday camps, clubs, hotels, Inns etc

These buildings are further subdivided into 5 groups

- A1 - Lodging Houses
- A2 - Family Private Dwellings
- A3 - Dormitories
- A4 - Flats
- A5 - Hotels

GROUP B: Educational buildings:

All those buildings which are meant for education from nursery to university are included in this group

Ex: schools, colleges, universities, training institutes etc

GROUP C: Institutional Buildings:

This group includes any building or part thereof, which is used for the purposes such as medical, health, recovering health after illness,

physical or mental diseases, care of infants or aged persons, panel detention etc. These buildings normally provide sleeping accommodation for the occupants.

GROUP D: Assembly Buildings:

This group includes any building or part or a building where groups of people assemble or gather for amusement; recreation, social, religious, patriotic or similar purpose for example theatres, cinema halls, museums, gymnasiums, restaurants, places of worship, dance halls, club rooms, passenger stations, public transportation services, open air theatres, swimming pools etc.

GROUP E- Business Buildings:

This group includes any building or part or a building which is used for purposes such as transaction of business, keeping of accounts and records etc; dispensaries and clinics, banks, city halls, court halls, libraries etc.

GROUP F – Mercantile Buildings:

This group includes any building or part of a building which is used for shops, stores, market, for safe and display of products or wares either whole sale or retail.

GROUP G – Industrial Buildings:

This group includes any building or part of a building or structure in which product of different kinds and properties are fabricated, assembled or processed. For example, laboratories, assembly plants, laundries, gas plants, power plants, refineries, dairies etc.

GROUP H – Storage Building:

This group includes those building structures which are primarily used for the storage structures which are primarily used for the

storage or sheltering of goods, waves or merchandise vehicles or animals, for example warehouses, cold storages, freight depots, store houses, transit sheds, truck terminals, garages etc.

GROUP J – Hazardous Building:

This group includes those building structures which are used for the storage, handling, manufacture or processing of materials which are liable to burn with extreme rapidity and prove hazards to health; building or building contents. Hazards may be due to fire; poisonous fumes or gases, explosions, ignitions etc from materials subjected to various operations. Buildings used for storage of gases under high pressure or for storage and handling of highly flammable liquids or explosives, fireworks etc are included in this group.

9.2 Component parts of building

The building basically consists of three parts namely,

- 1) Foundation
- 2) Plinth and
- 3) Super structure as shown in the fig 9.1

A building in general made of the following structural components

1. Foundation
2. Plinth
3. Walls and piers in super structure
4. Ground, basement and upper floors
5. Doors and windows
6. Sills, Lintels and weather shades
7. Roofs
8. Steps and stairs
9. Finishes for walls
10. Utility fixtures

Each of these components is an essential part of a building and requires due consideration in design and construction for their functional performance. The basic functional requirements of these components discusses in the following paragraphs.

1. Foundations:

The foundation is the most critical part of any structure and most of the failure is probably due to faulty foundations rather than any other cause. The purpose of foundation is to transmit the anticipated loads safety to the soil

Basic requirements:

1. To distribute the total load coming on the structure over a large bearing area so as to prevent it from any movement.
2. To load the bearing surface or area at a uniform rate so as to prevent any unequal or relative settlement.
3. To prevent the lateral movement of the structure

4. To secure a level or firm natural bed, upon which to lay the courses of masonry and also support the structure.
5. To increase the suitability of the structure as a whole, so as to prevent it from overturning or sliding against such as wind, rain, frost etc.

2. **Plinth:** This is the portion of structure between the surface of the surrounding ground and surface of the floor, immediately above the ground. As per Byelaws, the plinth should not be less than 45cm. The basic requirements of plinth area

- 1) To transmit the load of the super-structure to the foundation
- 2) To act as a retaining wall so as to keep the filling portion below the raised floor or the building
- 3) To protect the building from damp or moisture penetration into it
- 4) It enhances the architectural appearance of the building

3. **Walls and piers in super structure:** The primary function of walls is to enclose or liquid space. A load-bearing wall in the super structure should satisfy the following requirements.

Strengths, stability, weather resistance, fire resistance, heat insulation, sound insulation, privacy and security.

4. **Ground basement and upper floors:** The main function of a floor is to provide support of occupants, furniture and equipment of a building and the function of providing different floors is to devoid the building into different levels for the purpose of creating more accommodation within the limited space. The floor should satisfy the following functional requirements.

Page 126**Building Materials & Construction**

1. Strength and stability
2. Durability and dampness
3. Heat insulation
4. Sound insulation and fire resistance

5. Doors and windows: The main function of doors in a building is to serve us a connecting link between internal parts and also to allow the free movement outside the building. Windows are generally provided for the proper ventilation and lighting of a building.

The following are the functional requirements

1. Weather resistance
2. Sound and thermal insulation
3. Damp prevention and terminate-proofing
4. Fire resistance and durability
5. Privacy and security

6. Sills. Lintels and weather shades:

Windowsills are provided between the bottom of window frame and wall below, to protect the top of wall from wear and tear. The actual frame of door or window is not strong enough to support the weight of the wall above the strong enough to support the weight of the wall above the openings and a separate structural element has, therefore to be introduced. This is known as lintel and is similar to a beam. Weather shades on ehhajjas are generally combined with lintels of windows to protect from the weather elements such as sun, rain, frost etc.

7. Roofs:

A roof is the uppermost part of the building whose main function is to enclose the space and to protect the same from the effects of

weather elements such as rain, sun, wind, heat, snow etc. A good roof is just as essential as a safe foundation. The functional requirements of the roof are as follows.

- i) Strength and stability- strong and stable enough to take up anticipated loads
- ii) Weather resistance – resistance to wind, rain, sun, snow etc
- iii) Heat insulation - should provide adequate insulation against heat
- iv) Sound insulation – should provide adequate degree of insulation against sound from external sources.
- v) Fire resistance – Should offer the adequate degree of fire resistance.
- vi) Day lighting – The provides day light in buildings with large floor area i.e., industrial buildings through window in the roof.

8.Steps and Stairs: A stair is a structural consists of number of steps leading from one floor to another. The main functions of stairs are

- i. To provide means of communication between the various floors for everyday use
- ii. To escape from upper floors in the case of fire

To perform these functions, the stairs should satisfy the following requirements in design and construction.

- i) **Strength and stability-** Strong and stable enough to carry the anticipated loads.

- ii) **Fire resistance-** The stairs should be made of the fire resisting material and they provide safe means of escape in the event of fire.
- iii) **Sound Insulation:** If it is necessary to insulate the stairs from the sound either through the proper design and use of insulating materials or separating stair structure from the building structure.
- iv) **Weather resistance-** The stairs, if exposed to open air, should offer sufficient resistance to weather elements such as rain, heat etc.
- v) **Comfort and convenience:** proper design and proper location of steps in a building offer several advantages such as comfort and efficiency in vertical movement, natural light and ventilation; safety in emergency etc.

9.Finishes for walls: The finishes of several types such as pointing, plastering, painting, types such as pointing, plastering, painting, distempering, decorative colour washing etc applied on the walls. The main function of these finishes are

- a. Protect structure from the sun, rain, snow etc.
- b. Provide a true, even and smooth finished surface and also to improve the aesthetic appearance of the structure.
- c. Rectify rather cover, to some extent, the poor or defective workmanship
- d. Cover up the unsound and porous materials used in the construction

10.Utility Fixtures: These are the built in items of an unmovable nature, which add considerably to the utility of a building and hence

termed as utility fixtures. The most common of such built-in fixtures are: cupboards, shelves, smokeless chulas etc. These features are generally provided in the recesses for storing valuable articles, clothes etc. The recesses in wall structure reduce its strength, so they are avoided in the modern construction of houses.

* * *

1. According to national building code of India; 1970 the buildings are classified as

- (i) Group A – Residential Buildings
- (ii) Group B – Educational Buildings
- (iii) Group C – Institutional Buildings
- (iv) Group D – Assembly Buildings
- (v) Group E – Business Buildings
- (vi) Group F – Mercantile Buildings
- (vii) Group G – Industrial Buildings
- (viii) Group H – Storage Buildings
- (ix) Group J – Herzardous buildings

2. A building basically consists of

- (i) Foundation
- (ii) Plinth
- (iii) Super structure

3. A Building in general made of the following structural members

- (i) Foundation
- (ii) Plinth
- (iii) Walls and piers in super structure
- (iv) Ground, basement and structure
- (v) Ground, basement and upper floors
- (vi) Doors and windows
- (vii) Sills, lintels and weather shades
- (viii) Roofs
- (ix) Steps and stairs
- (x) Finishes for walls
- (xi) Utility fixtures

SHORT ANSWER QUESTIONS

1. Define substructure.
2. Define superstructure.
3. What are the structural components of a building?
4. Define plinth.
5. Name any four types classification based on N.B.C.

ESSAY TYPE QUESTIONS

1. Explain the structural components of building.
2. Explain the classification of buildings.

* * *

CHAPTER – 10

FOUNDATIONS

Every structure consists of two parts. (1) Foundation and (2) Super structure. The lowest artificially prepared parts of the structure which are in direct contact with the ground and which transmit the loads of the structure to the ground are known as Foundation or Substructure. The solid ground on which the foundation rest is called the “foundation bed” or foundation soil and it ultimately bears the load and interacts with the foundations of buildings.

10.1 Objects of foundations:

Foundations are provided for the following purposes

- 1) To distribute the total load coming on the structure on large area.
- 2) To support the structure
- 3) To give enough stability to the structures against various distributing forces such as wind, rain etc.
- 4) To prepare a level surface for concreting and masonry work.

The general inspection of site of work serves as a good for determine the type of foundation, to be adopted for the proposed work and in addition, it helps in getting the data w.r.to the following items.

- i) Behavior of ground due to variations in depth of water table
- ii) Disposal of storm water at site
- iii) Nature of soil by visual examination
- iv) Movement of ground due to any reason etc.

10.2 Bearing capacity: The ability of the foundation material, weather soil or rock to carry loads safely.

Methods of determine the bearing capacity of soil:

The bearing capacity of soil is determined by any one of the following methods

- (i) Method of loading
- (ii) Method of dropping a weight

I. Method of loading

Procedure to carry out the test:

1. A square pit of required size is excavated upto 5 times the side of steel plate to be used. At the centre of pit, square hole is dig, which is same ratio to that of breadth to depth of pit.
2. The bottom of the hole is made level
3. The steel plate is put up in the hole and then platform is prepared as shown in fig 10.1.

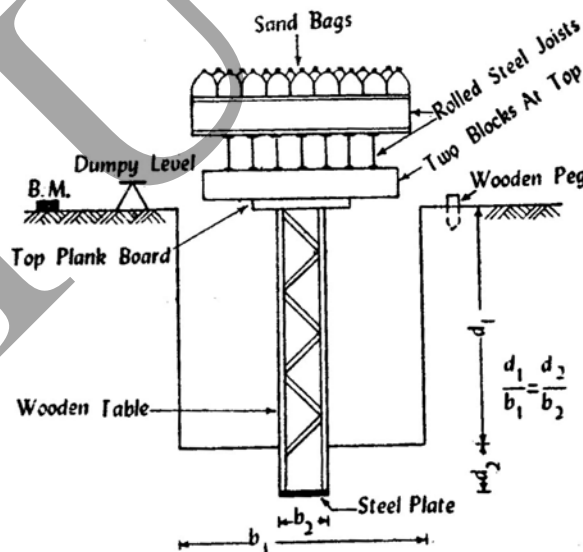

Fig 10.1 Method of loading

4. The amount of initial load is decided according to the type of the soil to be tested
5. A level is planted to note the setting of steel plate w.r.to the permanent benchmark.
6. The load is to be kept on platform till the settlement of the ground ceases or stops
7. The load is increased by a suitable amount, usually 0.5 tonnes and the procedure is continued
8. The recording of results is carried out in the following proforma.

Date and time of taking reading	Load	Increase in settlement	Total settlement	Remarks	
	0.5 tonne	a b c -	a a+b a+b+c -	settlement ceases	
	1.0 tonne	a1 b1 c1	a+b+c+a1 a+b+c+a1+b1 a+b+c+a1+b1+c1		
					settlement ceases

9. The settlement of the ground will be fairly is proportion to the load upto a certain limit, when the bearing power of soil exceeded, the settlement will be out of the proportion.
10. The bearing capacity and safe bearing capacity of soil are calculated by using the following

Bearing capacity of soil in tones/m²

Maximum load

= -----

Area of steel plate

Safe bearing capacity of soil in tones/m²

Bearing capacity of soil

= -----

Factor of safety

Note:

- 1) This method can also be used for confirming the known bearing power of a soil
- 2) The loading should applied without shock
- 3) Dial gauges or deflect meters to record the settlement instead of level & staff for the accuracy upto 0.02mm
- 4) The zero corrections should be deducted from the observed settlement to get actual settlements zero correction is the settlement due to adjustment of soil particles under the action of loading
- 5) The bearing capacity of sandy soil and gravelly soil is affected to the extent of 50% by presence of water table. Water should be pumped out before placing the steel plate
- 6) The results obtained by this method are fairly accurate and reliable.

II. Method of dropping a weight:

In this method, a substance of known weight is dropped from a known height as shown in 10.2. The depth of impression made by the weight on the soil is noted. Then the bearing capacity of the soil is worked out as follows.

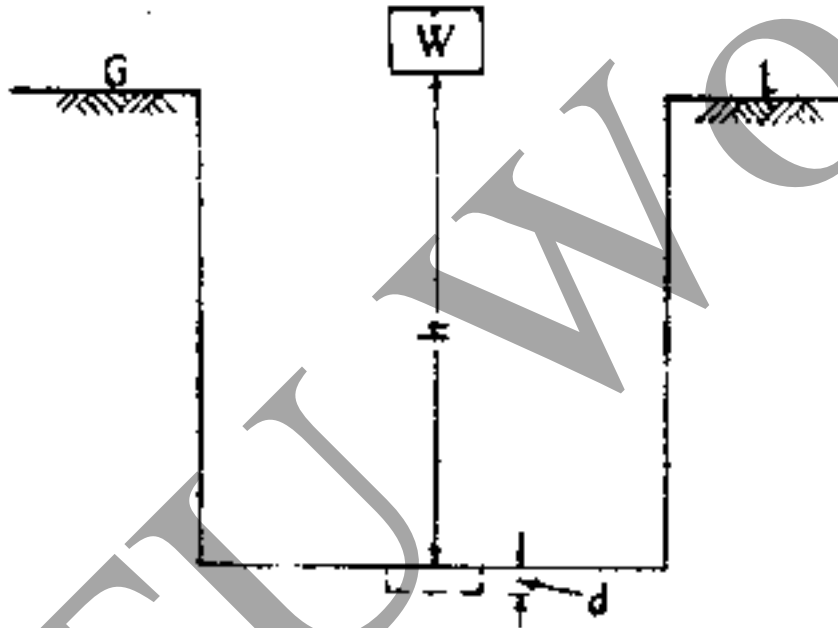

Fig 10.2 Method of Dropping Weight

Ultimate resistance of soil

$$R = \frac{w \times h}{d}$$

where R – Resistance of soil

A – cross section area of the substance

h - Height

w - weight of substance

∴ Safe bearing capacity of soil per unit area

$$= R / A \times f$$

Where f – factor of safety

The results obtained by this method are approximate and hence, this method is used for minor engineering structures or at places where first method would be impracticable.

10.3 Types of soils – Bearing Capacity: Ultimately the load of the structure is coming on the soil and hence, it is of utmost importance to know the strength and behavior of the soil. The term bearing power or bearing capacity of soil is used to indicate the maximum load per unit area, which the soils resist safely without displacement. Dividing the ultimate bearing capacity of a soil by a factor of safety, the safe bearing capacity of a soil is obtained. Max. safe bearing capacity of different types of soils are given in table 10.1.

S.No.	Type of Soil	Max. safe bearing capacity t/m ²
1.	Soft, wet clay or muddy clay	5
2.	Black cotton soil	15
3.	Soft clay	10
4.	Moist clay, and sand clay Mixture	15
5.	Medium clay	25
6.	Compact clay	45
7.	Fine, loose and dry sand	10
8.	Medium, compact and dry sand	25
9.	Compact sand	45
10.	Loose gravel	25

11.	Compact gravel	45
12.	Soft rocks	45
13.	Laminated rock such as sand stone & Lime stone	165
14.	Hard rocks such as granite, diorite, trap	330

Table 10.1

10.4 Types of foundations:

Depending upon their nature and depth, foundations have been categorized as follows

- (i) Open foundations or shallow foundations
- (ii) Deep foundations

I. **Open foundations or shallow foundations:** This is most common type of foundation and can be laid using open excavation by allowing natural slopes on all sides. This type of foundation is practicable for a depth of about 5m and is normally convenient above the water table. The base of the structure is enlarged or spread to provide individual support. Since the spread foundations are constructed in open excavations, therefore they are termed as open foundations. This type of foundation is provided for structure of moderate height built on sufficiently firm dry ground. The various types of spread footings are:

1. Wall footing
2. Isolated footing
3. Combined footing
4. Inverted arch footing

5. Continuous footing
6. Cantilever footing
7. Grillage footing

1. **Wall Footing:** These footings can be either simple or stepped. The base course of these footings can be concrete or entirely of one material simple footing are used for light structures. They have only one projection beyond the width of the wall. The base width of the concrete base course should be equal to twice the width of wall. The depth of concrete bed is atleast twice the projection as shown in fig 10.3. The depth of concrete bed is calculated by

$$T = m \sqrt{\frac{p}{f}} \quad \text{where } t - \text{depth of concrete bed}$$

m – offset of concrete bed in cm

p – Load coming on soil kg/cm²

f – 0.03 x ultimate crushing strength of concrete in 28 days

The depth of the footing is calculated by the following formula

$$H = \frac{p}{w} \left(\frac{1 - \sin \phi}{1 + \sin \phi} \right)^2 \quad \text{where}$$

H - Minimum depth of footing in metre

p - Safe bearing capacity of soil in kg/m²

w - Unit wt. Of soil in kg/m³

ϕ - Angle of repose of the soil

the depth of footing is generally limited to 0.9m the width of footing should be calculated by divided the total load in kg/m run by the allowable bearing capacity of soil in kg/m².

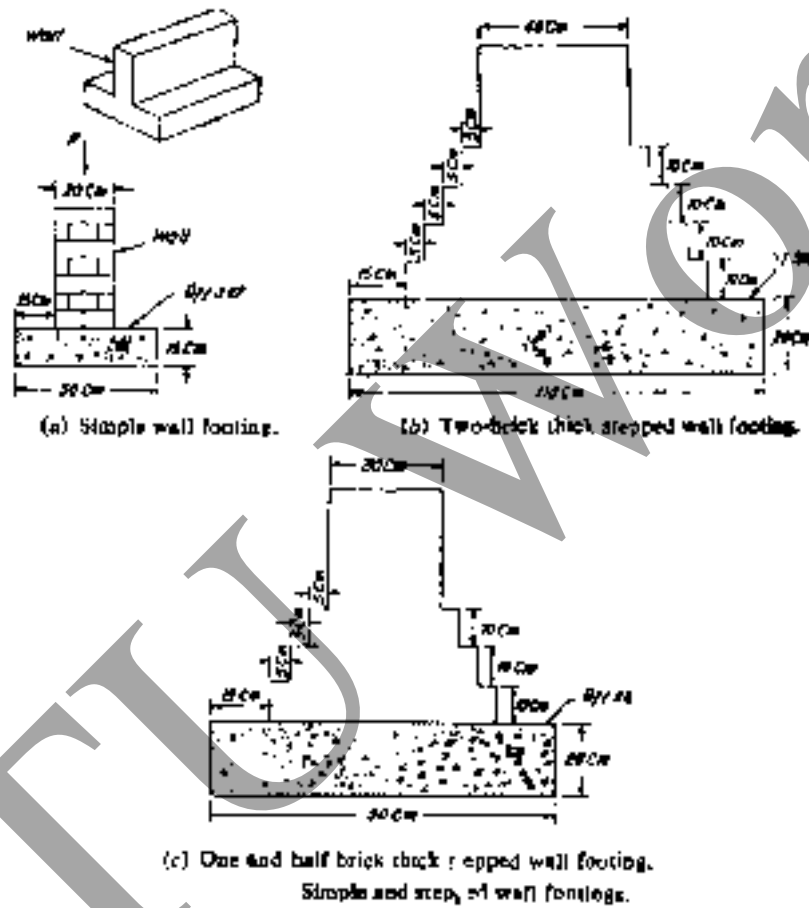

Fig 10.3

2. **Isolated Footings:** These are used to support individual columns. They can be of stepped type or have projections in the concrete base. In case of heavy loaded columns steel reinforcement is provided in both directions in concrete with 15cm offsets as shown in the fig10.4.

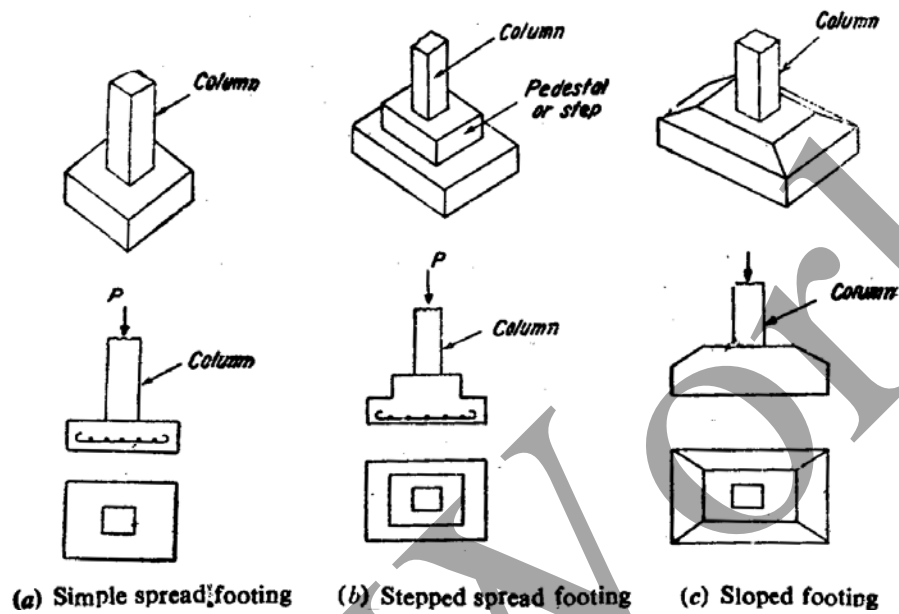

Fig 10.4 Types of Isolated Footings

3. **Combined Footing:** A combined footing supports two or more columns in a row. A Combined footing may be rectangular or trapezoidal constructed with reinforced concrete. The location of centre of gravity of column loads and centroid of the footing should coincide. The combined footing is as shown in fig10.5.

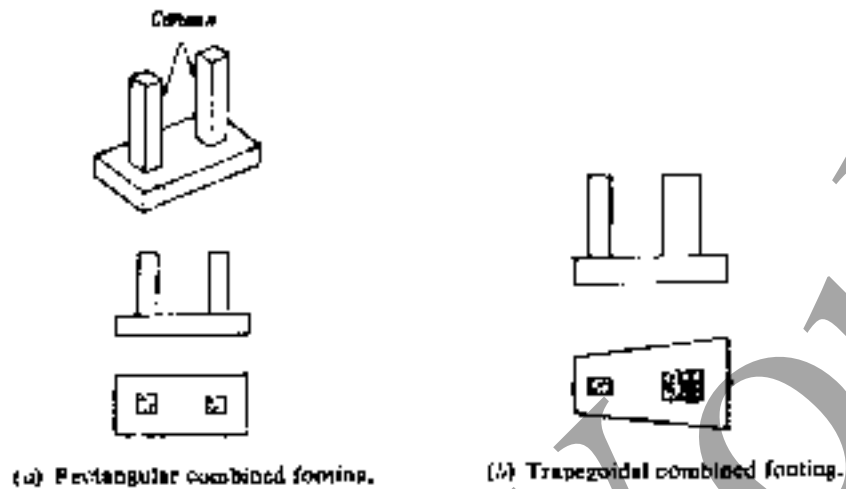

Fig 10.5 Combined Footings

4. **Inverted Arch Footing:** This type of construction is used on soft soils to reduce the depth of foundation loads above an opening are transmitted from supporting walls through inverted arches to the soil. In this type the end columns must be stable enough to resist the outward pressure caused by arch actions. The inverted arch footing is as shown in fig10.6.

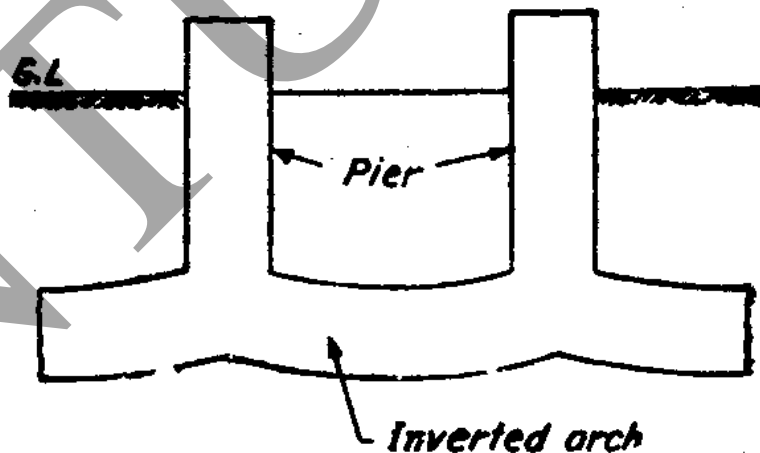

Fig 10.6 Inverted Footing

5. **Continuous Footing:** In this type of footing a single continuous R.C slab is produced as foundation of two or three or more columns in a row. This type of footing is suitable at locations liable to earthquake activities. This also prevents differential settlement in the structure. In order to have better stability a deeper beam is constructed in between the columns as shown in fig10.7.

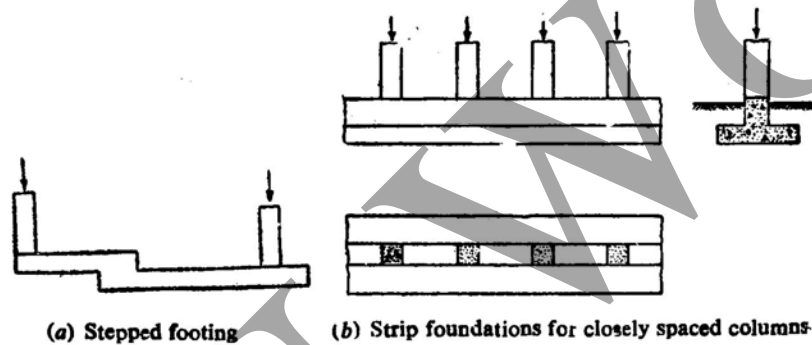

Fig 10.7 Continuous Footing

6. **Strap or cantilever footing:** Strap footing consists of two or more individual footings connected by a beam called strap or cantilever footing or pump handle foundation. This type of foundation may be used where the distance between the columns is so great that combined trapezoidal footing becomes quite narrow with high bending moments strap or cantilever footing is as shown in fig 10.8.

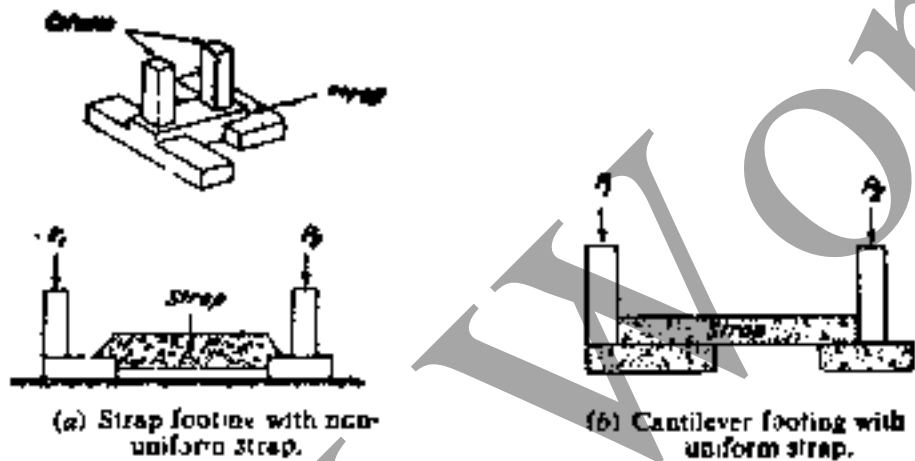

Fig 10.8 Strap or cantilever footing

7. **Grillage footing** : This type of footing is used to transmit heavy loads from steel columns to foundation soils having low bearing power. This type of foundation avoids deep excavation and provides necessary area at the base to reduce the intensity of pressure of the foundation soil is not stiff and there is a plenty of water with spring, the sides are protected by sharing. The grillage footing is as shown in fig 10.9.

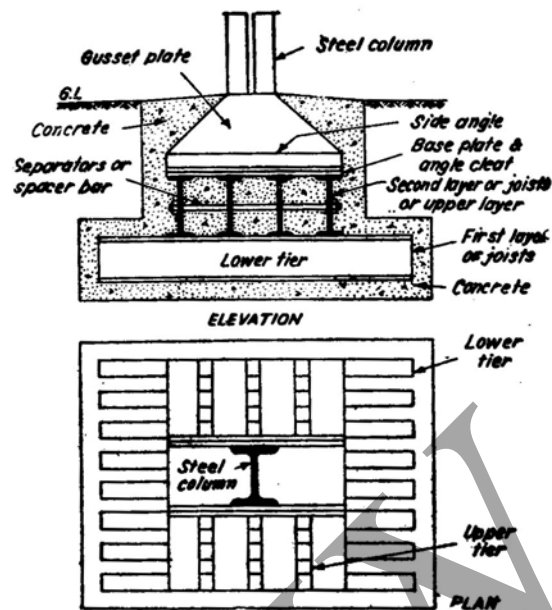

Fig 10.9 Grillage Footing

8. **Raft Foundation:** A raft or mat is a combined footing that covers the entire area beneath a structure and supports all the columns. When the allowable soil pressure is low or the structure loads are heavy the use of spread footings would cover more than one half of the area and it may be prove more economical to use raft foundation. There are also used where the soil mass contains compressible lenses so that the differential settlement would be difficult to control usually when the hard soil is not available within 1.5 to 2.5m, a raft foundation is adopted. The raft is composed of reinforced. Concrete beam with relatively thin slab underneath fig 10.10 shows different types of raft.

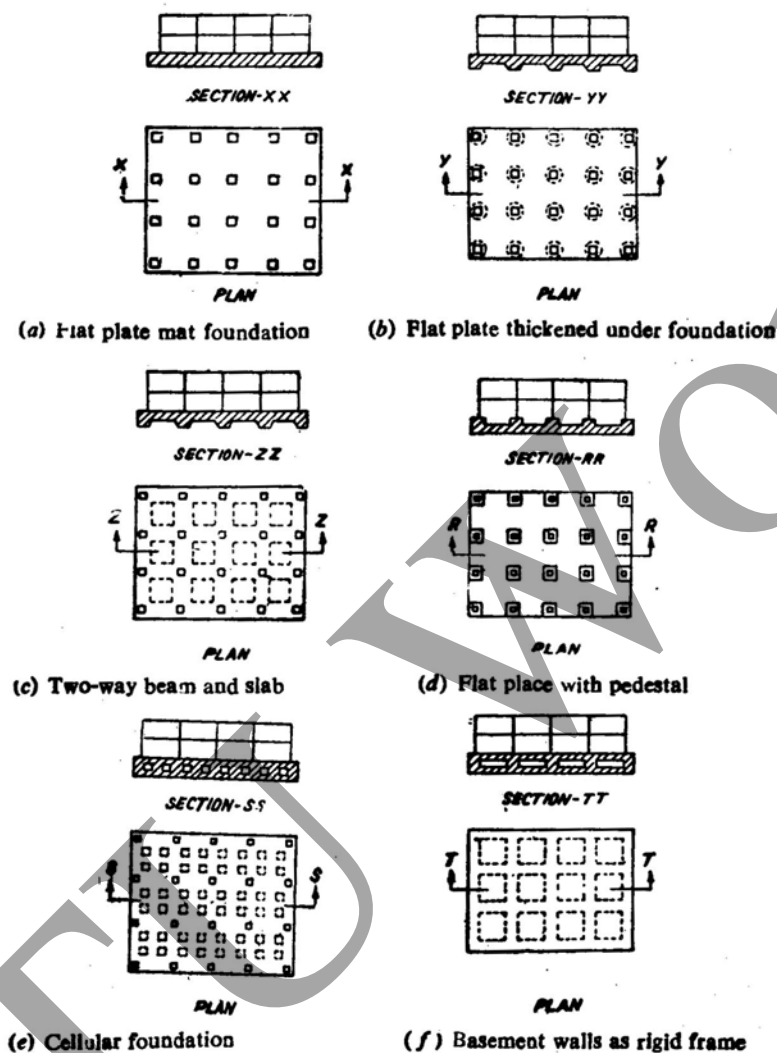

Fig 10.10 Different types of Raft Foundations

II Deep foundations:

These foundations carry loads from a structure through weak compressible soil or fills onto the stronger and less compressible soils or rocks at depth. These foundations are in general used as basements, buoyancy rafts, caissons, cylinders, shaft and piles.

- a) **Basements:** They are constructed in place in an open excavation. They are hollow slab structure designed to provide working or storage space below ground level. The structural design is governed by their functional requirements.
- b) **Buoyancy rafts:** They are hollow substructures designed to provide a buoyant substructure beneath with the net loading on the soil reduce to the desired low intensity.
- c) **Coissions:** They are hollow substructures designed to be constructed on or near the surface and then sunk as single units to their required level.
- d) **Cylinders:** They are small single cell coissions
- e) **Shaft foundations:** They are constructed within deep excavation supported by lining constructed in place subsequently filled with concrete.
- f) **Pile foundations:** Pile foundation is a construction for the foundation supported on piles. A pile is an element of construction composed of timber, concrete, or steel or a combination of them. Pile foundation may be defined as a column support type of a foundation, which may be cast in-situ or **Pre-cast**. This type of construction is adopted when the loose soil extends to a great depth. The load of the structure is transmitted by the piles to hard stratum below or it is resisted by the friction developed on the sides of pipes.

(i) **Classification based on the function**

- a) **Bearing piles-** Penetrate through soft soil and their bottom rest on a hard stratum
- b) **Friction piles-** The frictional resistance is equal to load coming on the piles as shown in the fig 10.11.

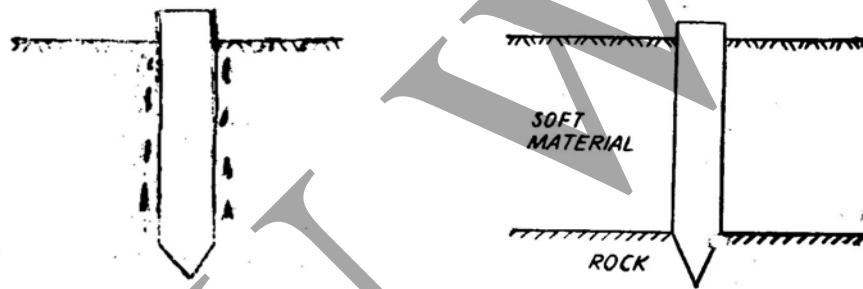

Fig 10.11 Friction pile & Bearing Pile

- c) **Screw piles-** Used for gravelly ground sand, mixed gravel ground etc as shown in fig 10.12.

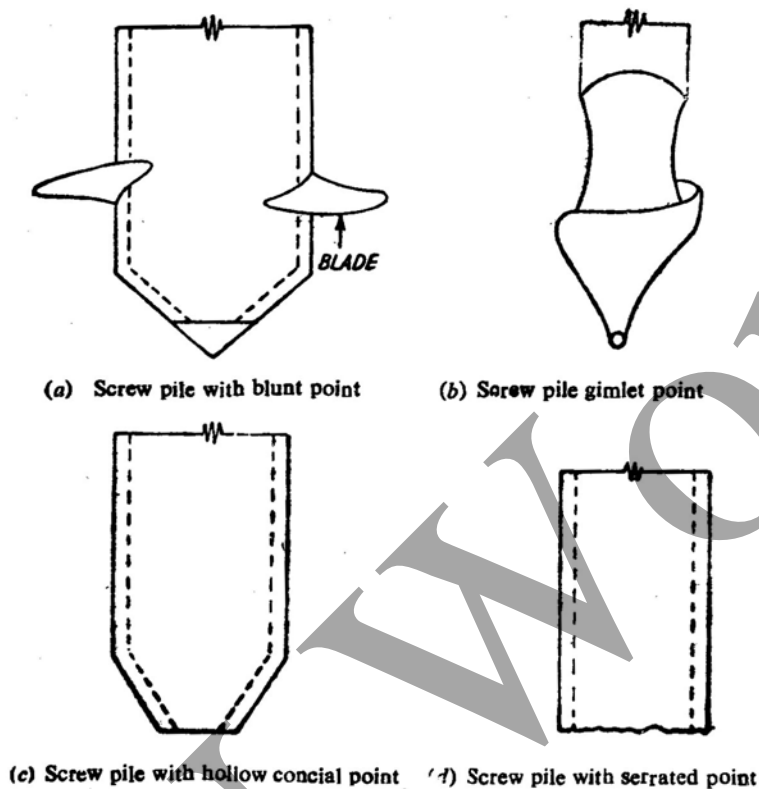

Fig 10.12 Different types of screw piles

- d) **Uplift piles**- when the structure subjected to uplift pressure.
- e) **Butter pile** – To resist large horizontal or inclined forces
- f) **Sheet pile**-used as bulk heads or a impervious cutoff
- (ii) **Classification based on materials and composition**
 - a) **Cement concrete piles**-Posses excellent compressive strength
 - 1) Precast
 - 2) Cast-in-site
 - a) Under reamed piles
 - b) Bored compaction piles as shown in fig 10.13.

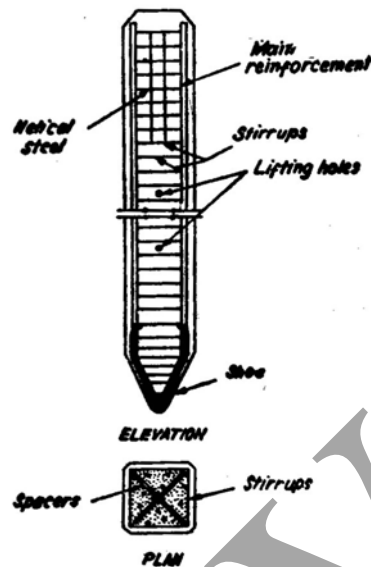

Fig 10.13. Pre-cast concrete Pile

- b) **Timber piles**-Small bearing capacity, not suitable for hard soil and economical
- c) **Steel piles**-With stand impact stresses and resist lateral forces
- d) **Sand piles**-Not suitable for loose or wet soils or where is a danger of scour. Easy to construct and irrespective of water table.
- e) **Composite piles**- combination of two different materials are used to form composite pile and suitable where the upper part of pile to project above the water table. Economical and easy to construct as shown in fig 10.14.

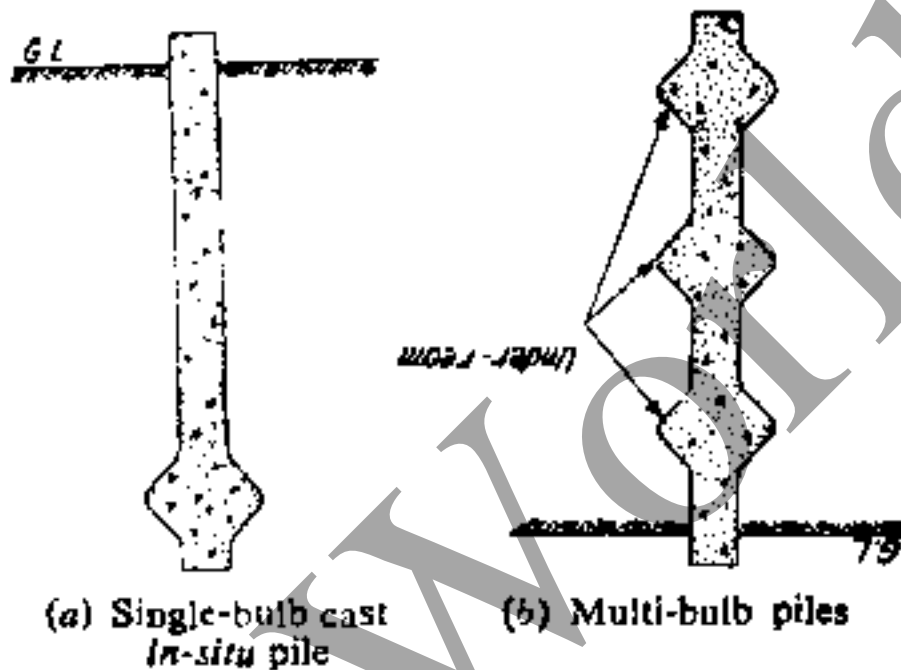

Fig 10.14 Under-reamed Piles

10.5 Requirements of a good foundation:

Following are the three basic requirements to be fulfilled by a foundation to be satisfactory

- 1) **Location** : The foundation should be located that it is able to resist any unexpected future influence which may adversely affect its performance. This aspect requires careful engineering judgement.
- 2) **Stability**: The foundation structure should be stable or safe against any possible failure
- 3) **Settlement**: The foundation structure should not settle or deflect to such an extent so as to impair its usefulness.

10.6 Causes of failure of good foundation:

The different causes for foundation failure are given below

1. Non uniform settlement of sub soil and masonry
2. Horizontal movement of the soil adjacent to structure
3. Alternate swelling and shrinkage in wet and dry cycles of the season
4. Lateral pressure due to lateral movement of earth tending to over turn the structure
5. Action of weathering agencies like sun, wind or rain
6. Lateral escape of the soil beneath the foundation of the structure
7. Roots trees and shrubs which penetrate the foundation

* * *

SYNOPSIS

1. Foundations is the lowest – artificially prepared parts of structure which are in direct contact with ground and which transmit the loads of the structure to the ground
2. The object of providing the foundation is
 - (i) To distribute the total load coming onto the structure on large area
 - (ii) To support the structure
 - (iii) To give stability to the structure
 - (iv) To prepare a level surface for concreting and masonry work
3. The bearing capacity of soil is used to indicate maximum load per unit area which the soil will resist safely without displacement
4. Depending upon their nature and depth, the foundations are
 - (i) Shallow foundation
 - (ii) Deep foundation
5. The shallow or open foundation are the following types usually about 5m and above water table
 - (i) Wall footing
 - (ii) Isolated footing
 - (iii) Combined footing
 - (iv) Inverted footing
 - (v) Continuous footing
 - (vi) Cantilever footing
 - (vii) Grillage footing
6. Deep foundations carry loads from a structure through weak compressible soils or fills are classified as
 - (i) Basements
 - (ii) Buoyancy rafts
 - (iii) Caissons

(iv) Shaft foundations

(v) Pile foundations

7. Classification based on the function

(i) Bearing piles

(ii) Friction piles

(iii) Screw piles

(iv) Uplift piles

(v) Batter piles

(vi) Sheet piles

8. Classification based on materials and composition

(i) Cement concrete piles a. Pre-cast b. Cast-in-site

(ii) Timber piles

(iii) Steel piles

(iv) Sand piles

(v) Composite piles

9. A good foundation should have the basic requirements

(i) Location

(ii) Stability

(iii) Settlement

10. The causes for the failure of foundations

(i) Non uniform settlement

(ii) Horizontal movement of the soil

(iii) Alternate swelling and shrinkage

(iv) Lateral pressure due to lateral movement of earth

(v) Action of weathering agencies

(vi) Lateral escape of the soil beneath the foundation of structure

(vii) Roots of trees and shrubs

SHORT ANSWER QUESTIONS

1. What are the main types of foundations?
2. What is the purpose of foundation?
3. What is meant by bearing capacity of soil?
4. Name the methods of determining the bearing capacity of soil?
5. Define safe bearing capacity.
6. Name any two causes of failure of foundations.
7. Name any two requirements of a good foundation
8. What is shallow foundation?
9. What is meant by deep foundation?
10. Name any four types of shallow foundations.
11. What is the purpose of raft foundation?
12. What is the grillage footing?

ESSAY TYPE QUESTIONS

1. Explain the requirements of good foundation.
2. What is bearing capacity and explain any one method to find the bearing capacity of soil?
3. Explain the causes for the foundation failures.
4. Explain the types of shallow foundations in brief.
5. What are deep foundations? Name the types.
6. Explain the functions of foundation.

* * *

CHAPTER – 11**MASONRY**

Masonry is defined as the art of construction in which building units, such as clay bricks, sand-lime, bricks, stones, Pre-cast hollow concrete blocks, concrete slabs, glass bricks, combination of some of these building units etc are arranged systematically and bonded together to form a homogeneous mass in such a manner that they can with stand point to other loads and transmit then through the mass without fail or disintegration.

Masonry can be classified into the following categories.

1. Stone masonry
2. Brick masonry
3. Hollow block concrete masonry
4. Reinforced masonry
5. Composite masonry

These can be further sub-divided into varies types depending upon workmanship and type of materials used.

Definitions of terms:

1. **Course:** A course is a horizontal layer of bricks stones
2. **Bed:** the surface of a stone perpendicular to the line of pressure of (lower surface of bricks or stones in each course)

3. **Back:** The inner surface of wall not exposed is called back. The material forming back is known as backing
4. **Face:** The exterior of the wall exposed to weather is known as face. The material used in the facing of wall is known as facing'
5. **Hearting:** It is the interior portion of a wall between facing and backing
6. **Head:** It is a brick or stone, which lies with its greatest length at right angles to the face of the work.
7. **Stretcher:** It is a brick or a stone which lies with its longest side parallel to the face of the work
8. **Bond:** The method of arranging bricks so that the individual units are tied together
9. **Spalls:** The chips of stones used for filling the interstices in stone masonry
10. **Quoins:** The stones used for the corners of walls of structure
11. **Bat:** It is a portion of a brick cut across the width.
12. **Closer:** It is the portion of a brick cut in such a manner that its one long face remains uncut
13. **Queen closer:** it is the portion of a brick obtained by cutting a brick length-wise into two portions

14. **King closer:** It is the portion of brick obtained by cutting off the triangular piece between the centre of one end and the centre of one side.
15. **Bevelled closer:** It is the portion of a brick in which the whole length of the brick is bevelled for maintaining half width at one end and full width at the other
16. **Frog:** It is an indentation or depression on the top face of a brick made with the object of forming a key for the mortar.
17. **Sill:** It is a horizontal stone, concrete or wood, employed for the purpose of shedding off rain water from the face of wall immediately below the window opening
18. **Corbel:** It is the extension of one or more course of stone or brick from the face of a wall to serve as a support for wall plates
19. **Templates:** Pieces of stones placed under the end of a beam to distribute load over a greater area.
20. **Coping:** It is the course placed upon the exposed top of an external wall to prevent the seepage of water
21. **Buttress:** It is a sloping or stepped masonry projection from a tall wall intended to strengthen the wall against the thrust of a roof as shown in fig 11.1

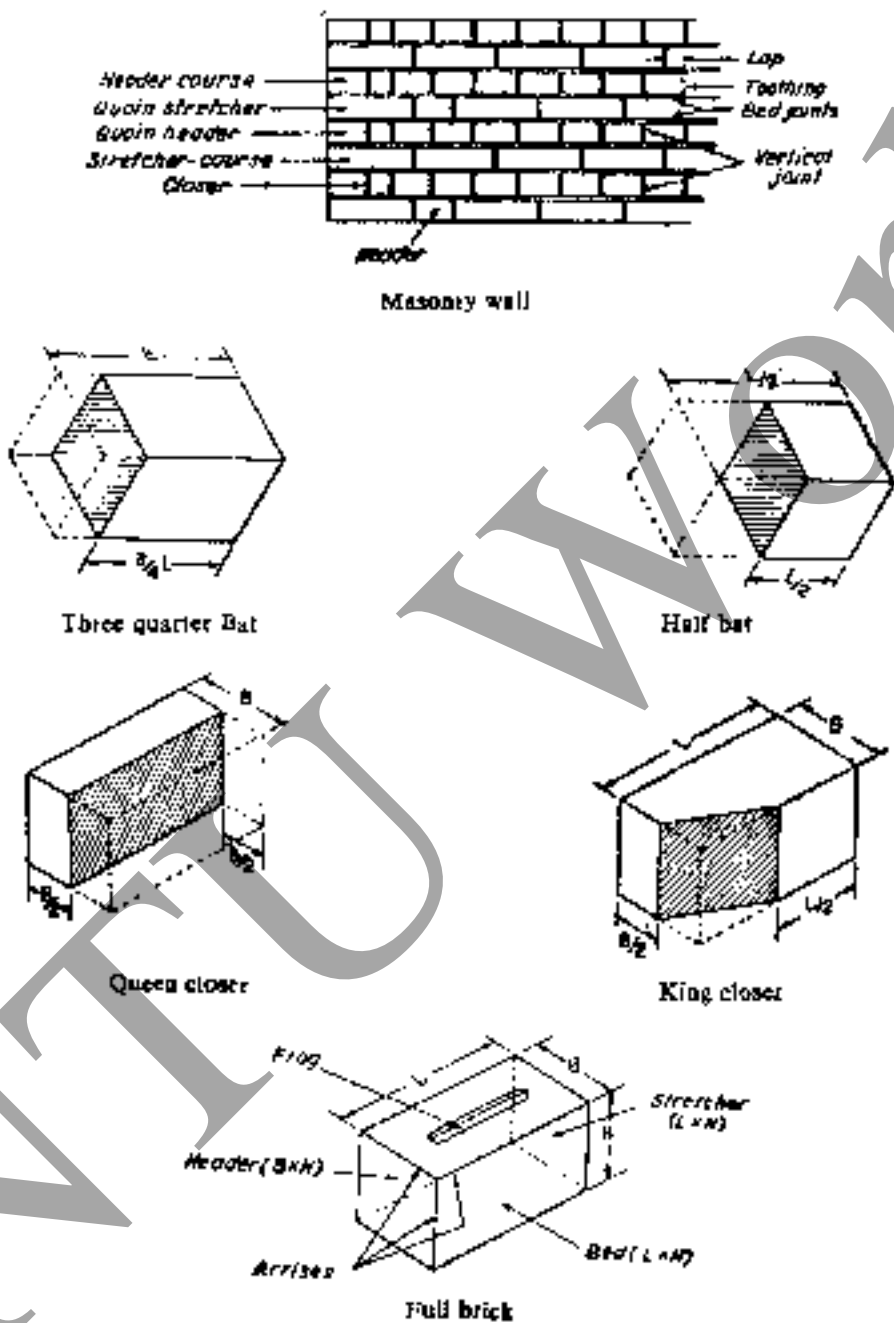

Fig 11.1 Definitions of terms

11.1 Stone masonry: The construction of stones bonded together with mortar is termed as stone masonry where the stones are available in a abundance in nature, on cutting and dressing to the proper shape, they provide an economical material for the construction of various building components such as walls, columns, footings, arches, lintels, beams etc.

Uses of stone masonry:

Stone masonry construction is used in

- (i) Building foundations, dams, monumental structures
- (ii) Building walls, piers, columns, pillars, light houses and architectural works.
- (iii) Arches, domes, lintels and beams
- (iv) Roofs, flems, paving jobs
- (v) Railway, bullest, black boards and electrical switch boards

11.1.1 Selection of stone for stone masonry:

The selection of stones for stone masonry depends upon

- a. Availability
- b. Ease of working
- c. Appearance
- d. Strength and stability
- e. Polishing characteristics
- f. Economy
- g. Durability

The table 11.1 given broadly outlines the different types of stones used for different purposes

S.No.	Purpose	Stones used
1.	Heavy engineering works Ex: stocks, break waters, light houses, bridges, piers	Granite, gneiss
2.	Buildings situated in industrial towns	Granite and compact sandstone
3.	Pavements, railway ballast, doorsits and steps	Granite slabs and slate
4.	Electrical switch board	Marble slabs and slate
5.	Fire resistance works	Compact sandstone
6.	Carving and ornamental works	Marble and laterite
7.	Face work and architectural purposes	Marble, granite closer gained sand stone

11.2 Tools required for stone masonry construction:

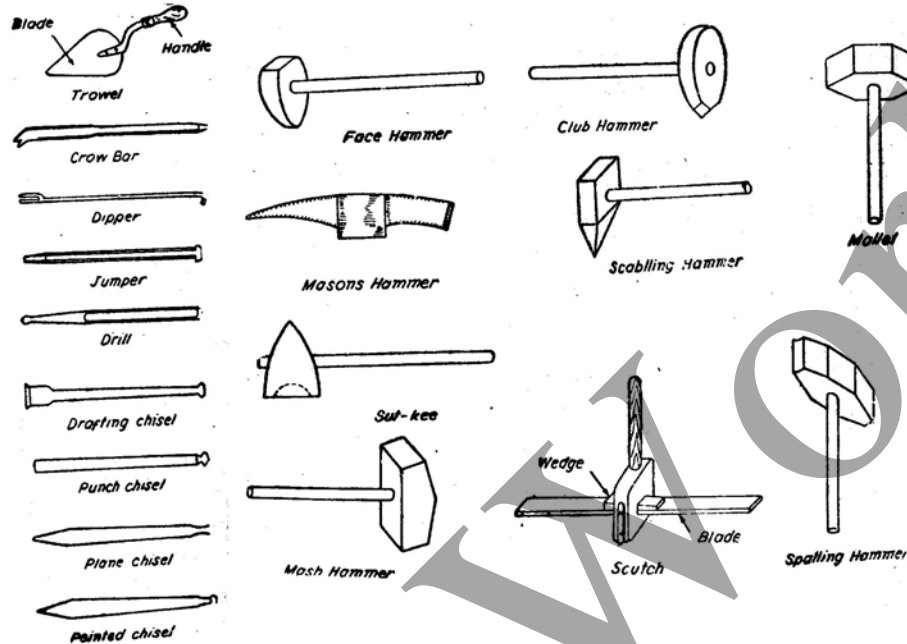

Fig 11.2 Tools for Stone Masonry

- a) **Trowel** : This is used to lift and spread mortar
- b) **Square**: This is made of flat steel having each arm about 0.5m long
- c) **Plumb rule and bob**: This is used to check the vertically of walls
- d) **Spirit level**: this is used to check the horizontality of walls
- e) **Line and pin**: This is used to maintain the alignment of the work in progress
- f) **Bevel**: The instrument used to set right angles
- g) **Pick axe**: This is employed for dressing of rough stone and split the stones in the quarry
- h) **Crowbar**: This is used to make stones in quarry
- i) **Chisels**: They are used to dress stones

- j) **Spall hammer:** This is heavy hammer used for rough dressing of stones
- k) **Mallet:** The wooden hammer used for driving of wooded headed chisels
- l) **Iron hammer:** This is used for carving of stones
- m) **Scabbling hammer:** This is used to break small projections of stones
- n) **Pitching tool:** This is used to make the stones of required size
- o) **Gauge:** this is employed to dress stones for spring course, cornice, coping etc
- p) **Claw tool:** This is employed for dressing the surface of stones
- q) **Nicker:** This is employed to draw fine chisel lines on the stone surface
- r) **Jumper:** They are used for boring holes
- s) **Wedge and feathers:** They are employed for cutting the stones after they have been bored with jumper.
- t) **Gad:** A small steel wedge used for splitting of stones
- u) **Drag:** This is employed to level a stone surface
- v) **Punch:** This is employed to dress roughly the stones
- w) **Handsaw:** This is used to cut soft stones
- x) **Cross-cut saw:** This is used to cut hard stones
- y) **Frame saw:** This is used to cut large blocks of stones.

11.3 Types of Stone Masonry:

Based on the arrangement of the stone in the construction and degree of refinement in the surface finish, the stone masonry can be classified broadly in the following two categories

1. Rubble masonry
2. Ashlar masonry

General principles in the stone masonry construction

1. The stones to be used for stone masonry should be hard, tough and durable.
2. The pressure acting on stones should be vertical
3. The stones should be perfectly dressed as per the requirements
4. The heads and bond stones should not be of a dumb bell shape.
5. In order to obtain uniform distribution of load, under the ends of girders, roof trusses etc large flat stones should be used
6. The beds of the stones and plan of the course should be at right angles to the slope in the case of sloping retaining wall
7. Wood boxing should be filled into walls having fine dressed stone work to protect it during further construction
8. The mortar to be used should be good quality and in the specified faces.
9. The instruction work of stone masonry should be raised uniformly.
10. The plumb bob should be used to check the vertically of erected wall
11. The stone masonry section should always be designed to take compression and not the tensile stresses
12. The masonry work should be properly cured after the completion of work for a period of 2 to 3 weeks
13. As per as possible broken stones or small stones chips should not used

14. Double scaffolding should be used for working at higher level
15. The masonry hearting should be properly packed with mortar and chips if necessary to avoid hallows
16. The properly wetted stones should be used to avoid mortar moisture being sucked

1) Rubble masonry: In this category, the stones used are either undressed or roughly dressed having wider joints. This can be further subdivided as uncoursed, coursed, random, dry, polygonal and bint.

(i) **Uncoursed rubble masonry:** This is the cheapest, roughest and poorest form of stone masonry. The stones used in this type of masonry very much vary in their shape and size and are directly obtained from quarry. Uncoursed rubble masonry can be divided into the following.

- a) Uncoursed random rubble
- b) Uncoursed squared rubble

a) **Uncoursed random rubble masonry:** The weak corners and edges are removed with mason's hammer. Generally, bigger stone blocks are employed at quoins and jambs to increase the strength of masonry.

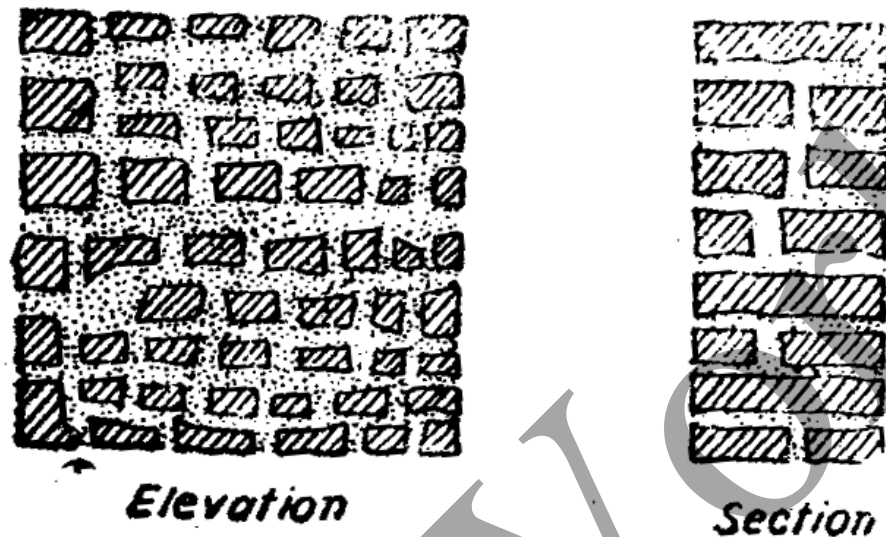

Fig 11.3 Uncoursed random rubble masonry

- b) **Uncoursed squared rubble:** In this type the stone blocks are made roughly square with hammer. Generally the facing stones are given hammer-dressed finish. Large stones are used as quoins. As far as possible the use of chips in bedding is avoided as shown in 11.4.

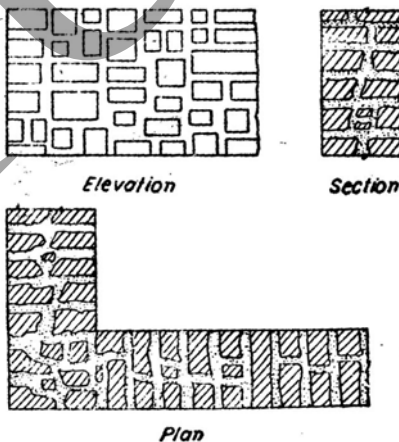

Fig 11.4 Uncoursed squared rubble masonry

- (ii) **Coursed random rubble:** This type of masonry is commonly used in the construction of low height walls of public buildings, residential buildings, abutment and piers of ordinary bridges. The stones of 5 to 20cm size are used in each course as shown in fig 11.5.

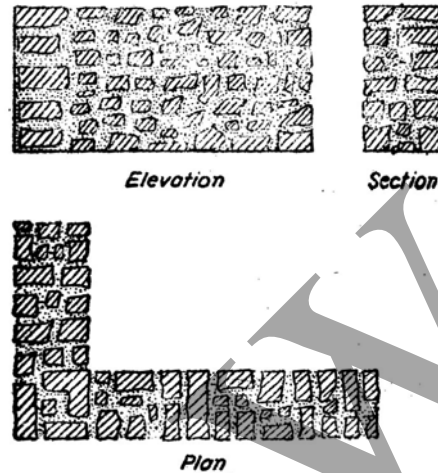

Fig 11.5 Coursed Random Rubble

- (iii) **Coursed squared rubble:** This type of masonry is made up of hammer squared stones facing with bonded backing of uncoursed random rubble masonry. The stones employed in each course are of equal height. The backing and facing construction, should be carried simultaneously. In order to avoid thick mortar joints, small chips may be used as shown in the fig 11.6.

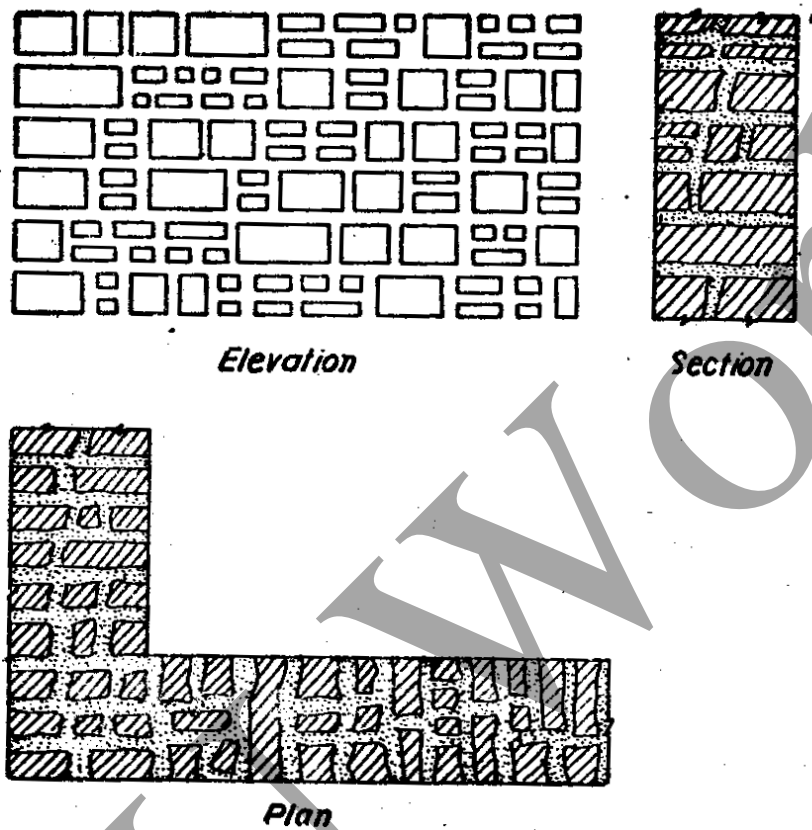

Fig 11.6 Coursed Squared Rubble Masonry

- (iv) **Built to regular course:** In this type of stone masonry the uniform height stones are used in horizontal layers not less than 13cm in height. Generally, the stone beds are hammered or chisel dressed to a depth of atleast 10cm from the face. The stones are arranged in such a manner so that the vertical joints of two consecutive course donot coincide with each other as shown in fig 11.7.

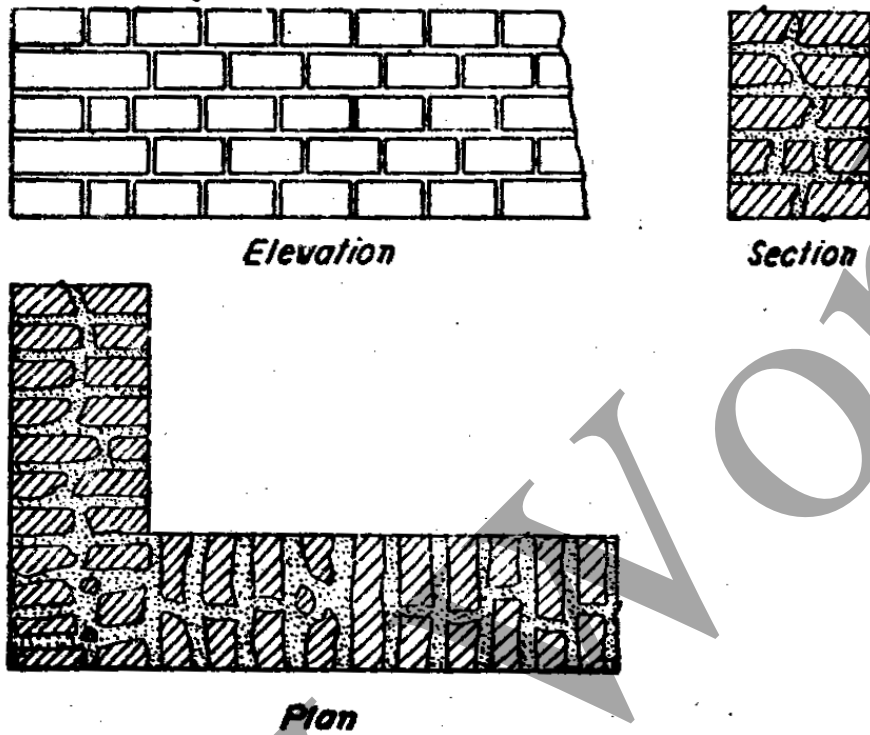

Fig 11.7 Built to regular courses

- (v) **Polygonal rubble masonry:** In this type of masonry the stones are roughly dressed to an irregular polygonal shape. The stones should be so arranged as to avoid long vertical joints in face work and to break joints as much as possible. Small stone chips should not be used to support the stones on the facing as shown in fig 11.8.

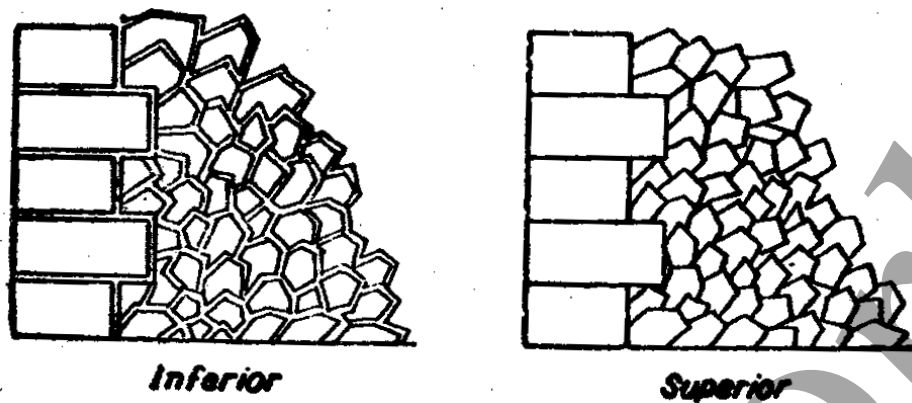

Fig. 11.8 Polygonal rubble masonry

- (vi) **Plint rubble masonry:** This type of masonry is used in the areas where the flint is available in plenty. The flint stones varying in thickness from 8 to 15cm and in length from 15 to 30cm are arranged in the facing in the form of coursed or uncoursed masonry as shown in fig 11.9.

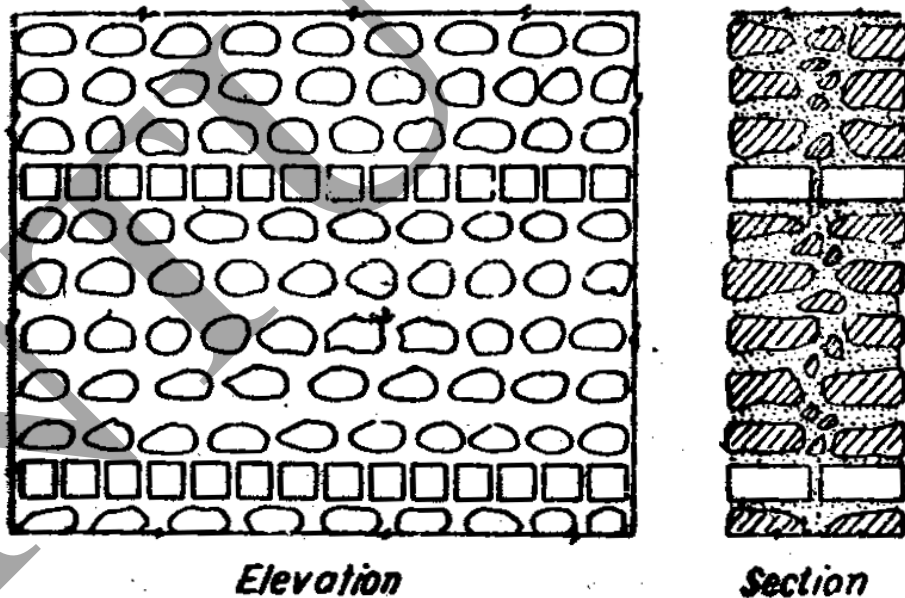

Fig 11.9 Plint Rubble Masonry

- (vii) **Dry rubble masonry:** This type of masonry is used in the construction of retaining walls pitching earthen dams and canal slopes in the form of random rubble masonry without any mortar. The hallow spaces left around stones should be tightly packed with smaller stone pieces as shown in fig 11.10.



Fig 11.10 Dry Rubble Masonry

2. **Ashlar Masonry:** This type of masonry is built from accurately dressed stones with uniform and fine joints of about 3mm thickness by arranging the stone blocks in various patterns. The backing of ashlar masonry walls may be built of ashlar masonry or rubble masonry. The size of stones blocks should be in proportion to wall thickness. The various types of masonry can be classified under the following categories as shown in fig 11.11 to fig 11.13 .

- (i) Ashlar fine
- (ii) Ashlar rough
- (iii) Ashlar rock or quarry faced

- (iv) Ashlar facing
- (v) Ashlar chamfered
- (vi) Ashlar block in course

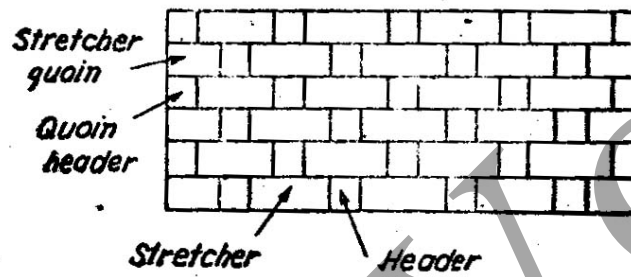

Fig 11.11 Ashlar Fine Masonry

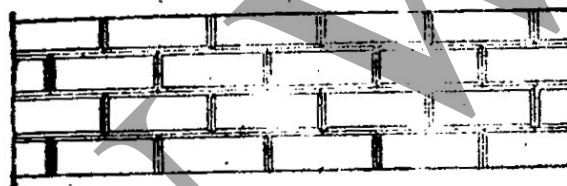

Fig 11.12 Ashlar chamfered Masonry

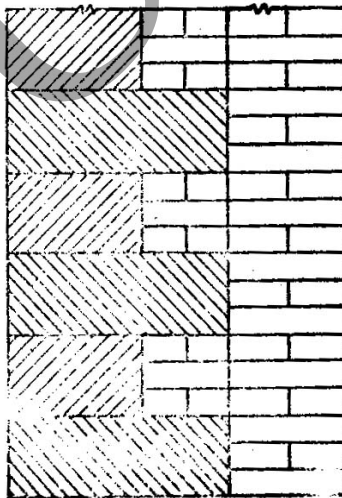

Fig 11.13 Ashlar Facing

11.5 Brick masonry:

Brick masonry is a unified mass obtained by systematic arrangement of laying bricks and bonding together with mortar. Brick is a building unit of hard inorganic clay material of size which can be conveniently handled. The brick masonry is used in foundations, walls, columns, buttresses, retaining structures window sills, jambs, corbels, copings ornamental brickwork, circular brickwork, fire places, flues, tall chimneys, cavity walls, thresholds, culverts, steps, floors, arches etc. The strength of brick masonry works depends upon the quality of bricks and type of mortar used.

Generally mortars are following types used for brick masonry

- (i) Mud mortar
- (ii) Cement mortar
- (iii) Cement lime mortar
- (iv) Lime surkhe mortar

General principles in brick masonry construction:

1. A good brick masonry should utilize bricks, which are sound, hard, well burnt and tough with uniform colour, shape and size.
2. The bricks should be compact, homogenous, free from holes, cracks, flaws, air-bubbles and stone lumps and soaked in water for atleast two hours before use
3. In the brickwork, the bricks should be laid on their beds with the frogs pointing upwards

4. The brick courses should be laid truly horizontal and should have truly vertical joints
5. As far as possible the use of brick – bats should be discouraged
6. As far as possible the brick wall should be raised uniformly less than 1.5m in day with proper bond.
7. When the mortar is green the face joints should be raked to a depth of 12 to 19mm in order to have a proper key for plastering or pointing.
8. In order to ensure continuous bond between the old and the new, the wall should be stopped with a toothed end.
9. Finished brickwork should be cured for a period of 2 to 3 weeks for lime mortar and 1 to 2 weeks for cement mortar
10. In order to carryout the brickwork at higher level, a single scaffolding is used.

11.6 Types of brick bonds:

Bonding is a process of arranging bricks and mortars to tie them together in a mass of brickwork. It should have a minimum of vertical joints in any part of the work.

Characteristics of brick bond or rules for bonding:

1. The brick masonry should have bricks of uniform shape and size

2. For satisfactory bondage the lap should be one-fourth of the brick along the length of the wall and half brick across thickness of the wall
3. The brick bats use should be discouraged
4. The vertical joints in the alternate courses should coincides with the centre line of the stretcher
5. The alternate courses the centre line of header should coincide with the centre line of stretcher, in course below or above it.
6. The stretcher should be used only in the facing while hearing should be done in the headers only

Classifications of bonds: The bonds can be classified as follows:

- (i) Stretcher bond
- (ii) Header bond
- (iii) English bond
- (iv) Double Flemish bond
- (v) Single Flemish bond
- (vi) Garden wall bond
- (vii) Facing bond
- (viii) Dutch bond
- (ix) Raking bond
- (x) Zigzag bond

- (xi) English cross bond
- (xii) Bonds in columns
- (xiii) Brick on edge bond or soldier course
- (xiv) Bonds at junction and squint junction

Stretcher bond: In this type of bond all the bricks are laid with their lengths in the direction of the wall. This pattern is used only for wall having thickness of 9cm only as shown in fig 11.14.

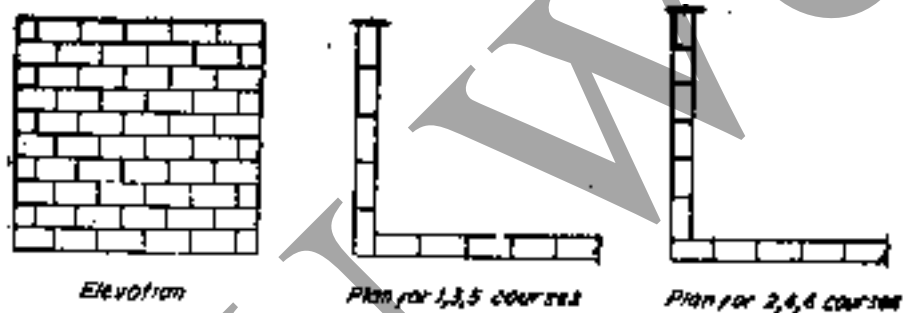

Fig 11.14 Stretcher Bond

Header bond: In this type of bond all the bricks are laid with their ends towards the face of the wall. This arrangement is suitable for one brick wall of curved wall and footings for better load distribution as shown in fig 11.15.

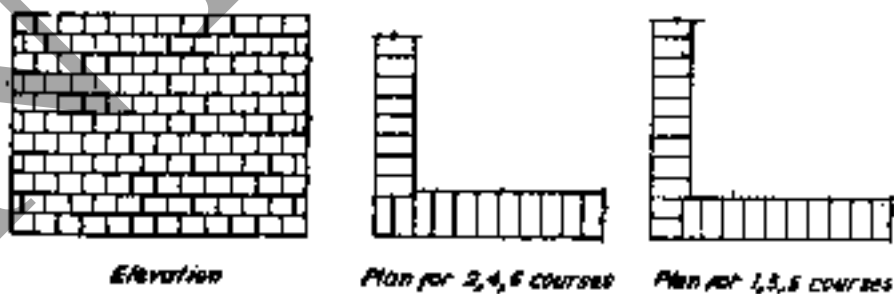

Fig 11.15 Header Bond

English bond: In this type of bond alternate course of headers and stretchers are laid. It is necessary to place queen closer in the heading course for breaking the joints vertically. The different english bonds are as shown in fig 11.16 and 11.17.

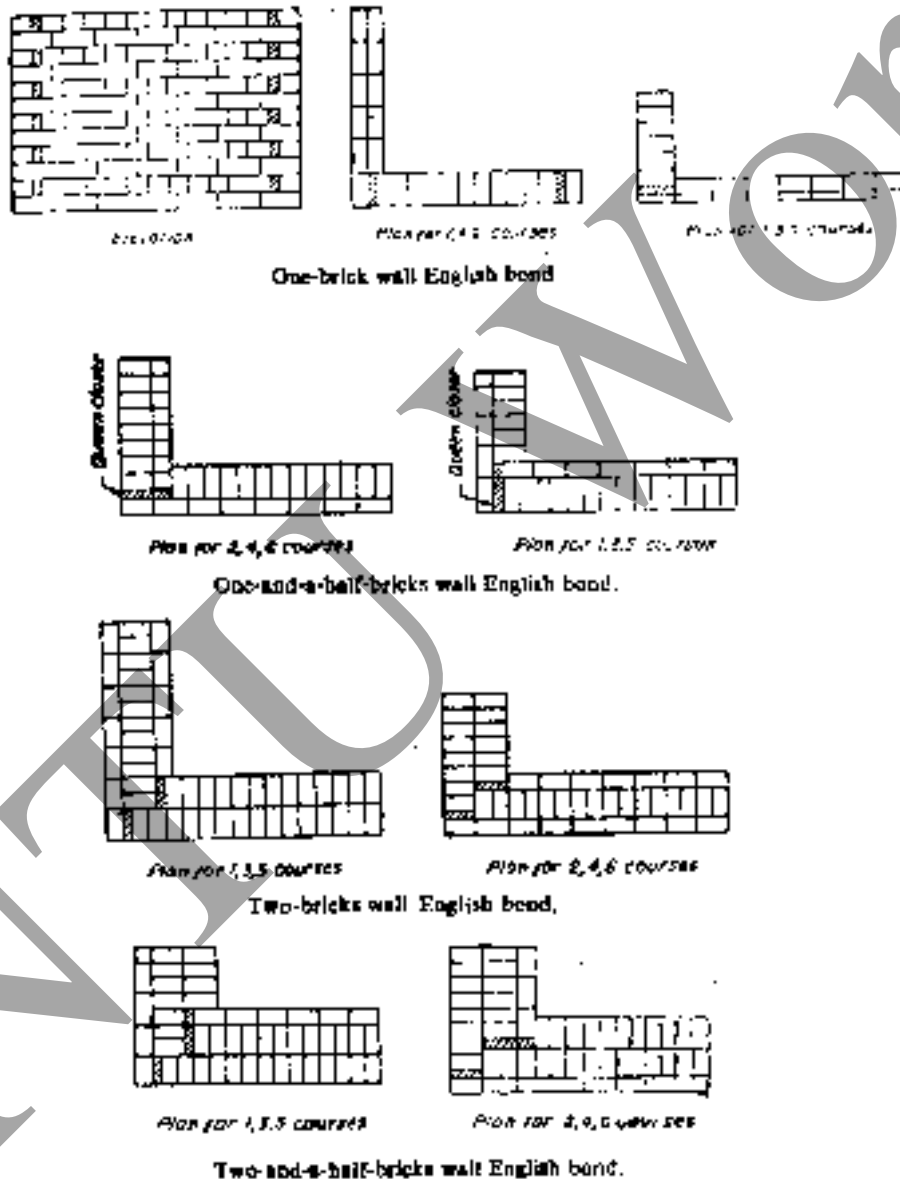

Fig 11.16 English Bond

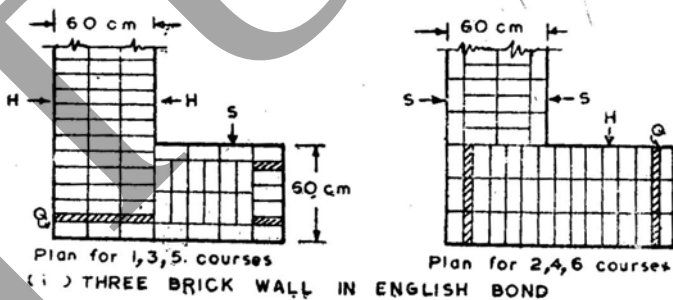
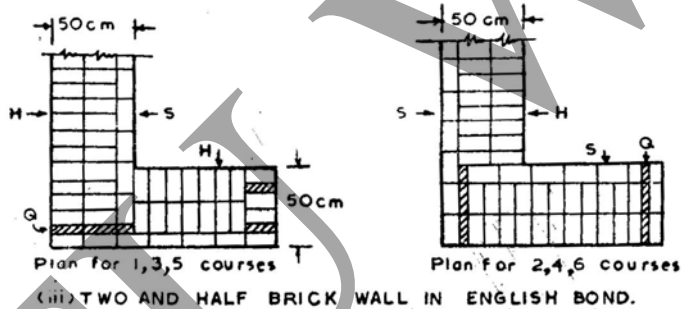
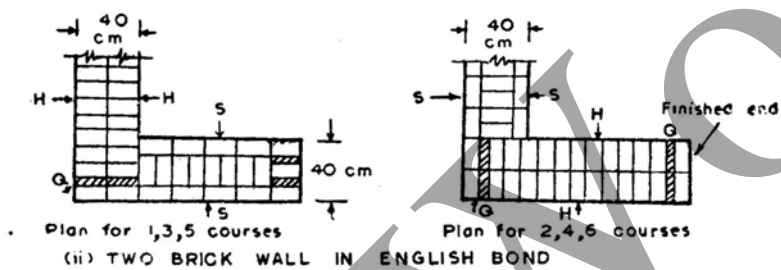
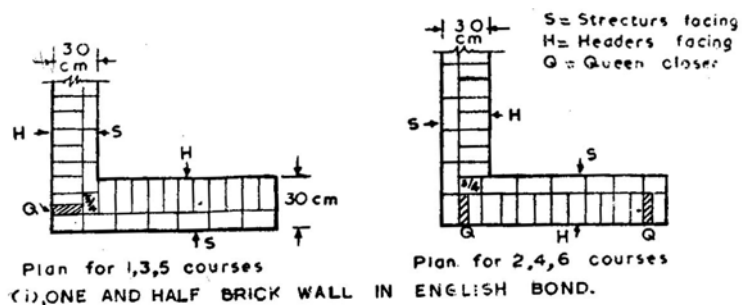
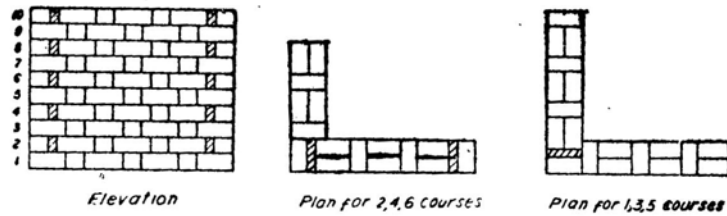

Fig 11.17 Alternate arrangements for various wall thicknesses in English Bond

Double Flemish bond: In this type, alternate heads and stretchers are laid in each course. The facing and backing are of the same

appearance brickbats and queen closers are used. The double Flemish bond is as shown in fig 11.18.



One-brick wall double flemish bond.

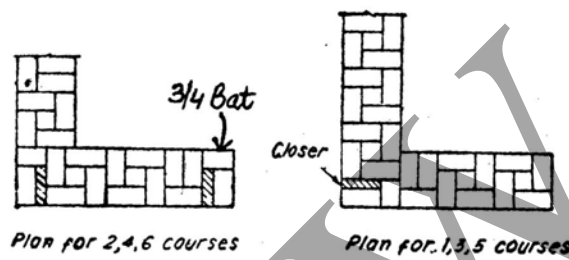

One-and-a-half-bricks double flemish bond.

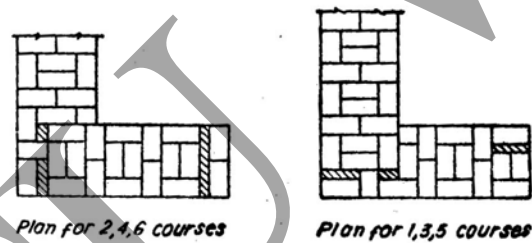

Two-bricks double flemish bond.

Fig 11.18 Double Flemish Bond

Single Flemish bond: This type of bond is comprised of double Flemish bond facing and English bond backing in each course. This type of construction partially possesses the strength of English bond, and appearance of Flemish bond. As this type of bond requires minimum thickness of $1\frac{1}{2}$ bricks so it cannot be used for

walls having thickness less than $1\frac{1}{2}$ bricks. The fig 11.19 shows the single Flemish bond.

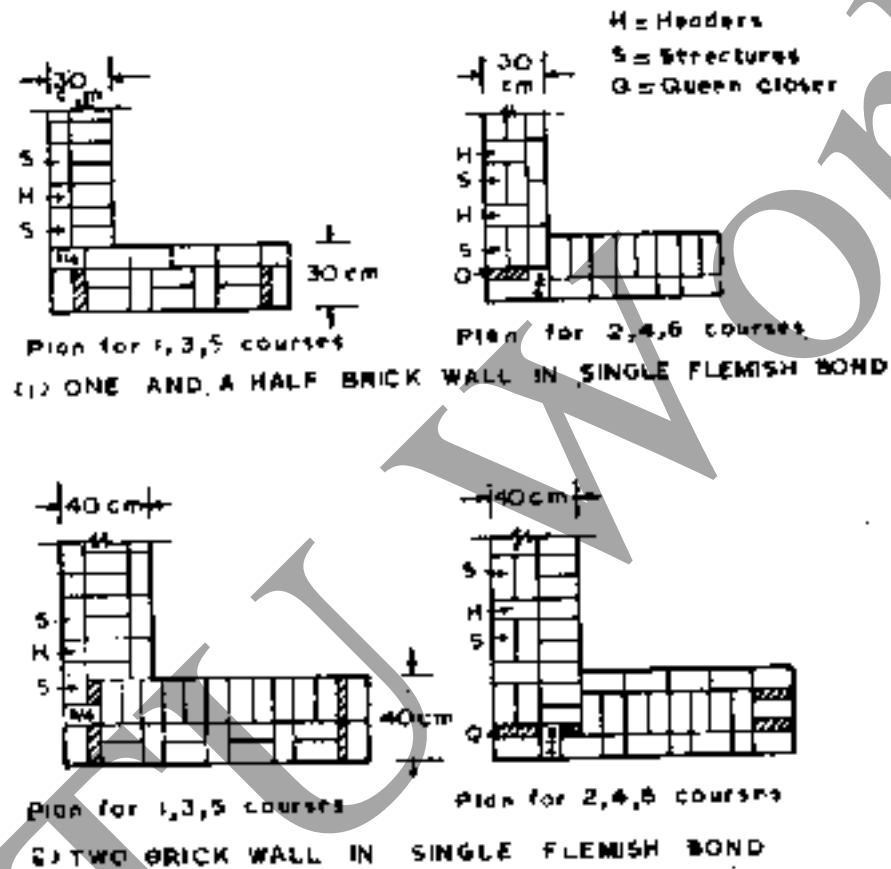

Fig 11.19 Single Flemish Bond

Garden wall bond: This type of bond is employed for the construction of garden walls, compound walls, boundary walls etc. This wall bond can be both English as well as Flemish as shown in the fig 11.20 & 11.21.

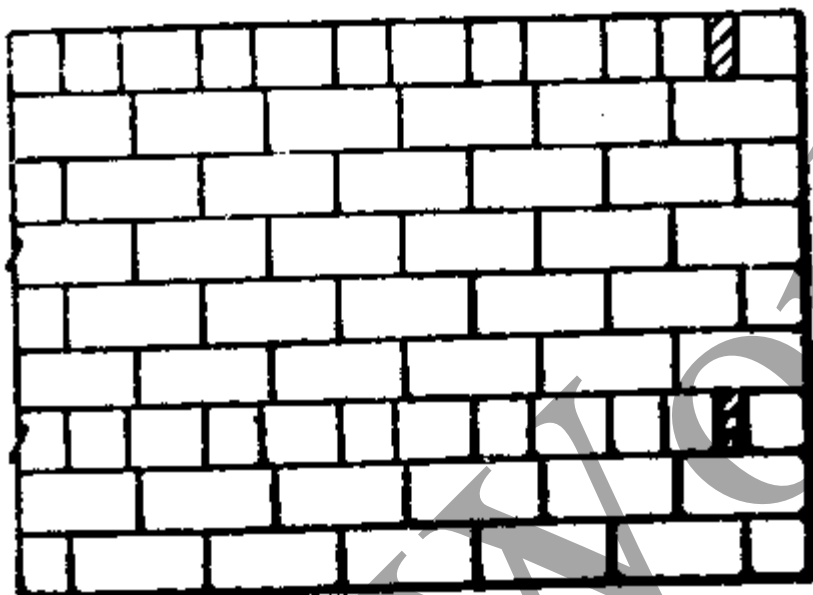

Fig 11.20 English Garden Wall Bond

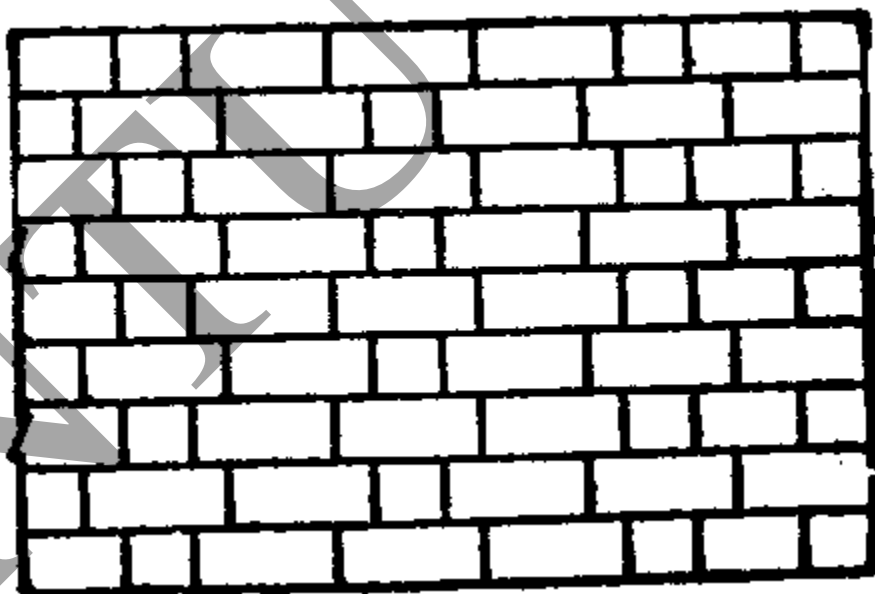

Fig 11.21 Flemish Garden Wall Bond

Facing bond: In this type of bond bricks of different thickness are used in the facing and backing of the wall. In this case, a header course is placed after several stretcher courses. In this type of bond, the distance between the successive heading courses is equal to common multiple of thickness of backing and facing bricks.

Dutch bond: This is the modified form of English bond. The corners of the wall provided with dutch bond are quite strong. The alternate courses in this type of bond are headers and stretchers. In stretcher course $\frac{3}{4}$ bat is used as quoin. A header is placed next to the $\frac{3}{4}$ bat in every alternate stretcher course as shown in the fig 11.22.

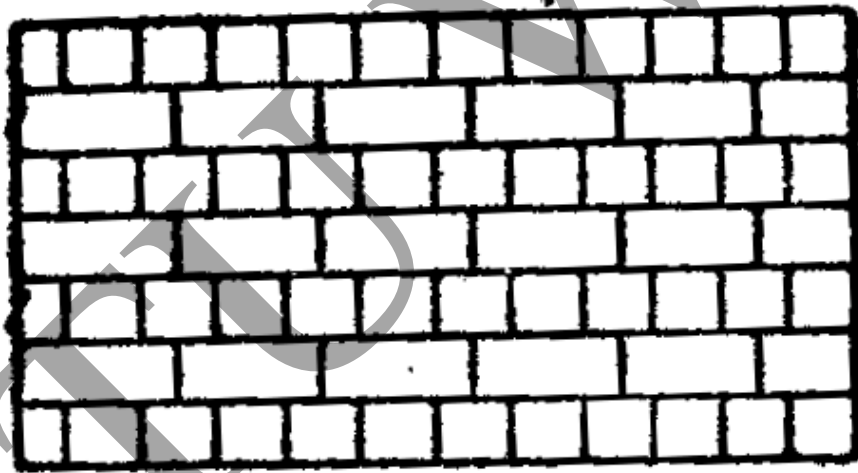

Fig 11.22 Dutch Bond

Raking bond: In this type of bond alternate courses are placed in different directions to get maximum strength in the wall. The racking courses are laid to certain interval along the height of the wall in very thick wall having number of headers more than the no.

of stretchers between the facing and backing. Thus the raking course rectifies the defect of low longitudinal, stiffness in thick wall. This is of two types a. Herring bone bond (placed at 45° in both direction) b. Diagonal bond as shown in fig 11.23.

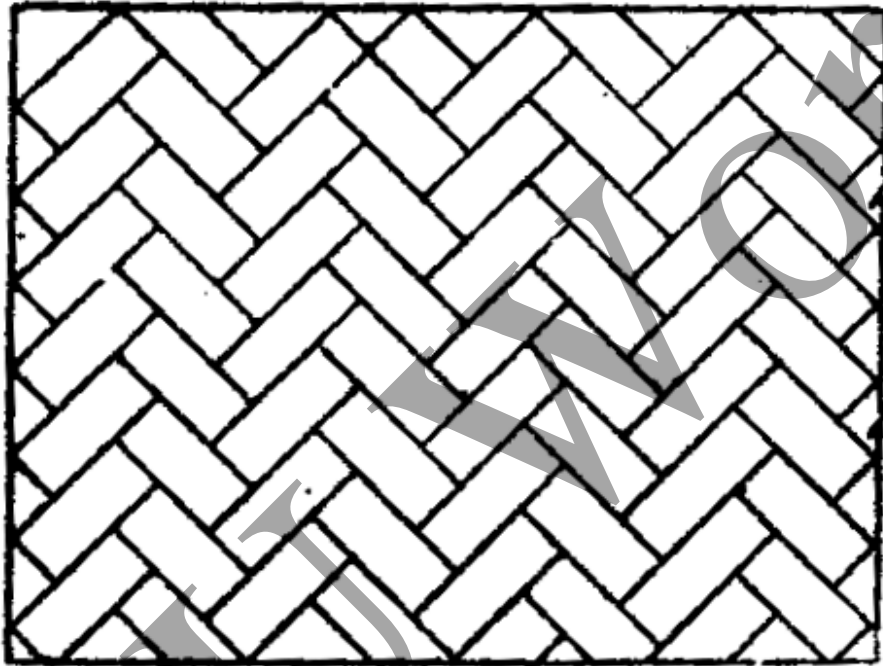

Fig 11.23 Herring Bone Bond

Zigzag bond: This type of bond very much similar to herring bone bond. The only difference is that bricks are laid in zigzag way and used for paving the brick floor as shown in fig 11.24

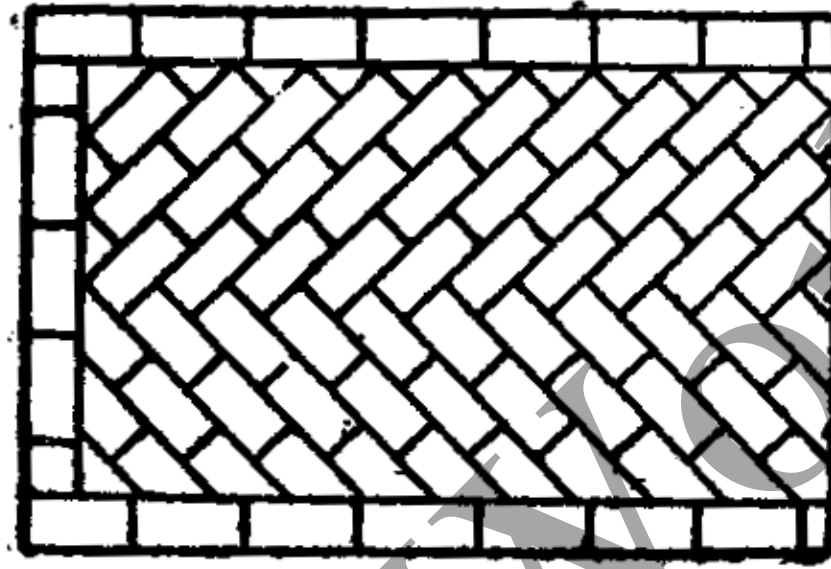

Fig 11.24 Zigzag Bond

English cross bond: This type of bond is aesthetically more sound and possesses greater strength than English bond. In this bond every alternate stretcher course has a header placed next to the quoins stretchers and rest of the details are similar to English bond as shown in fig 11.25

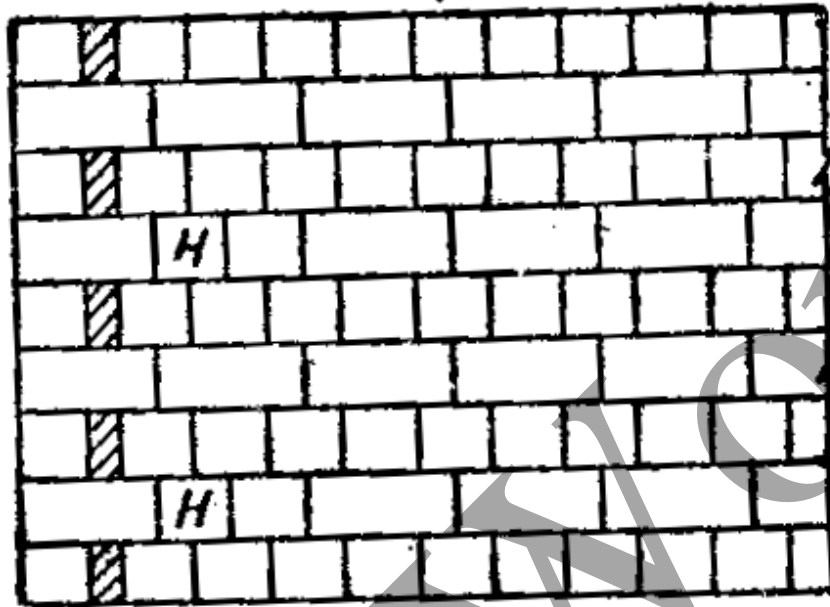

Fig 11.25 English Cross Bond

Brick on edge bond or soldier course: In this type of bond, the bricks are laid on edge. The bricks are placed as headers and stretchers in alternate courses in such a manner that headers are placed on bed and the stretchers are placed on edge forming a continuous cavity. This bond is weak in strength but economical.

Bonds in columns: Generally English bond or double Flemish bond are used for column construction. In case of circular or octagonal construction moulded bricks are used. The various arrangements of bricks in different column shapes are as shown in fig 11.26.

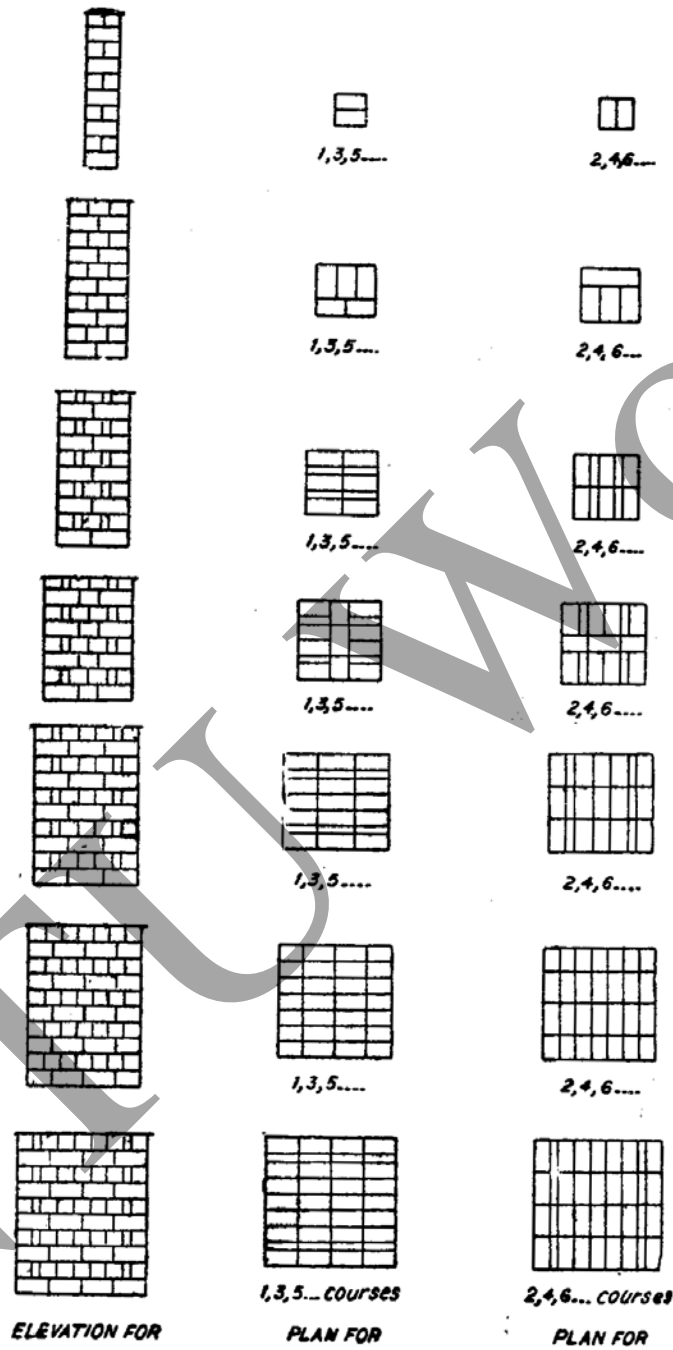

fig 11.26 Bonds in columns

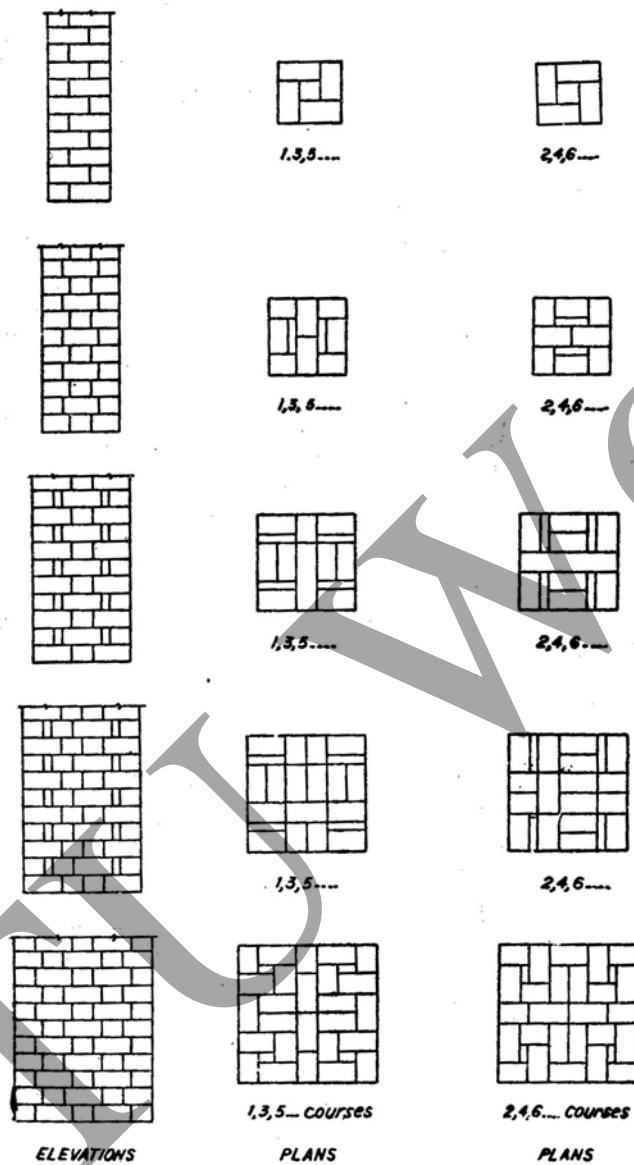
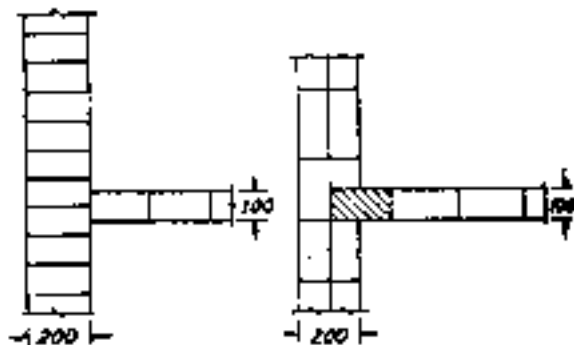

Fig 11.27 Columns in Double Flemish bond

Bonds at junction: When two walls meet or intersect each other, the meeting point is known as junction

- (i) **For tee junction-** English or double Flemish is used as shown in fig 11.28.



Plans for one-brick Tee-Junction.

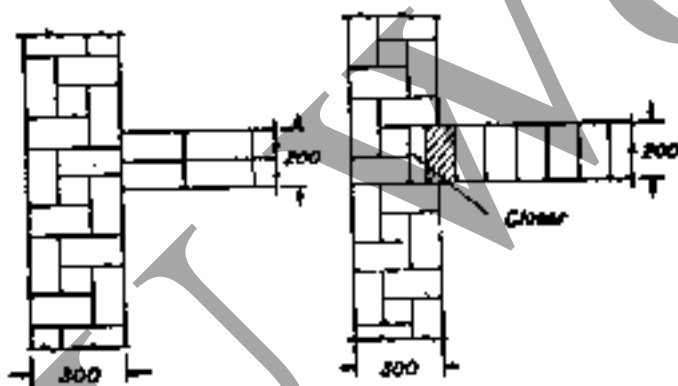

Plans for one-and-a-half brick Tee-Junction.
Fig. 8-39. Tee-Junction in English Bond.

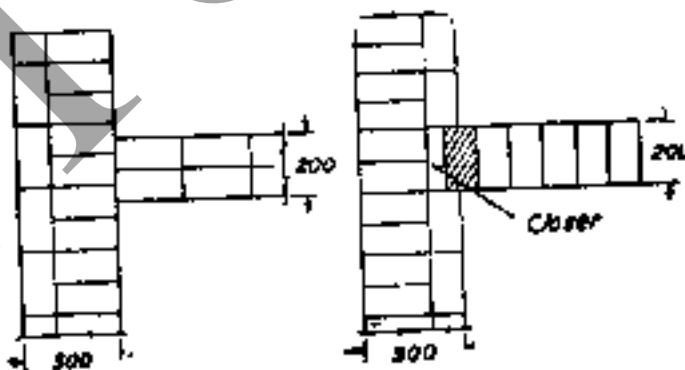

Fig 11.28 Bonds in Tee-Junction

Masonry

Page 189

(ii) For cross junctions – English bond is used as shown in fig. 11.29

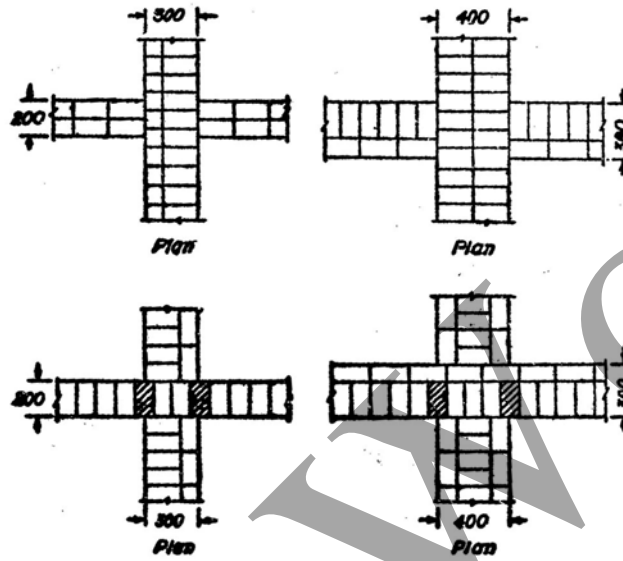

Fig 11.29 Cross Junctions in english bond

* * *

SYNOPSIS

1. Masonry is art of construction in which buildings units bricks, stones etc are arranged systematically and binded with cement & sand mixture
2. The masonry is classified as
 - (i) Stone masonry
 - (ii) Brick masonry
 - (iii)Hallow Masonry
 - (iv)Re-forced masonry
 - (v) Composite Masonry
3. The stone masonry is useful for foundations, dams, walls, piers, columns, arches, domes, lintels, beams, roofs, floors, railway ballest, black boards and electrical switch boards
4. Stone masonry is divided
 - (i) Rubble masonry
 - (ii) Ashlar masonry
5. The brick masonry is a unified mass obtained by systematically arrangement of laying brick and bonded together with mortar.
6. The brick mortar generally the following types
 - (i) Mud mortar
 - (ii) Cement mortar
 - (iii)Cement lime mortar
 - (iv)Lime surkhi mortar
7. Bonding is a process of arranging bricks and mortars to tie them together in a mass of brickwork

8. The bonds can be classified as
- (i) Stretcher bond
 - (ii) Header bond
 - (iii) English bond
 - (iv) Double flemish bond
 - (v) Single flemish bond
 - (vi) Garden wall bond
 - (vii) Faving bond
 - (viii) Dutch bond
 - (ix) Raking bond
 - (x) Zig zag bond
 - (xi) English cross bond
 - (xii) Bonds in columns
 - (xiii) Brick on edge bond or soldier course
 - (xiv) Bonds at junction and squint junction

SHORT ANSWER QUESTIONS

1. What is masonry?
2. Name the types of masonry
3. Define the following
 - a. Strecher
 - b. Quoins
 - c. Queen closer
 - d. King closer
 - e. Frog
 - f. Sill
4. Define stone masonry
5. What are the uses of stone masonry?
6. Name the import stones used in the construction of stone masonry
7. What is the use of following tools in the construction of stone masonry
 - a. Plumb rule
 - b. Spirit level
 - c. Line and pin
 - d. Bevel
 - e. Mallet
 - f. Chisel
 - g. Scabbling hammer
 - h. Jumper
 - i. Gauge
8. Define brick masonry
9. What are the uses of brick masonry
10. Name the important types of stone masonry

ESSAY TYPE QUESTIONS

1. What is stone masonry? Explain the uses of stone masonry
2. Explain the following with neat sketch a) king closer b) queen closer.
3. What are factors to be considered for the selection of stone for stone masonry?
4. Explain different types of stones used for various purposes
5. Explain the types of tools and their uses for stone masonry construction
6. What are the general principles adopted in the stone masonry construction
7. Explain the types of stone masonry
8. Explain the types of brick masonry
9. What are principles adopted in brick masonry construction?
10. Compare the merits and demerits of stone masonry and brick masonry.

* * *

CHAPTER – 12**FLOORS**

In order to sub-divide the portion between the plinth level or basement level and roof level, solid constructions are carried out. These constructions are known as floors and exposed top surface of floors are termed as floorings. Ground floors or basement floors, which directly rest on the ground, do not require the provision of a floor. But they are provided with suitable type of flooring.

12.1 Types of Floors:

Floors are classified into two categories

1. Timber Floors
2. Composite Floors

1. **Timber Floors:** In this floor, only timber is used as a material.

Timber floors are further divided into four types.

- a. Basement or Ground floor of timber
- b. Single Joist timber beam
- c. Double Joist timber beam
- d. Framed triple joist timber floor.

Features of Timber Floors:

(i) **Floor Boards:** These boards are provided at the top of bridging joists and they form the wearing surface of the floor. The width varies from 100mm to 200mm and thickness varies from 20mm to 40mm. the

Floors

Page 195

thickness may be changes when a floor subject to heavy traffic from 60 to 80mm. The floor boards are joined and widened by any suitable joint as shown in the figure.12.1

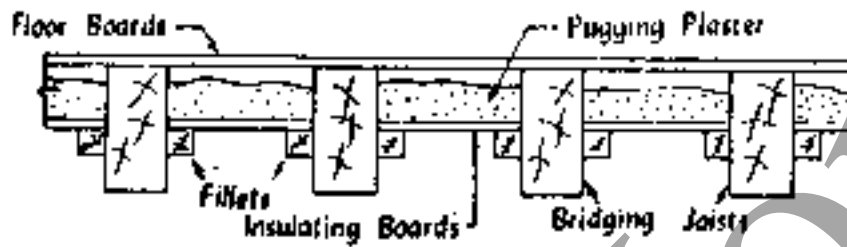

Fig 12.1 Pugging

(ii) **Floor Ceilings:** To make the underside of the floor flat and to improve the appearance as a whole, ceilings may be provided rest on bridging joists or binders. The ceilings may consists of plaster boards or sheets of asbestors cement or some suitable material. In order to make ceilings strong and durable, ceiling joists may be provided at right angles to the bridging joists or the binders.

(i) **Pugging:** In order to make the timber floor sound proof, pugging may be resorted. Pugging plaster is a mixture of chopped straw and mortar. Insulating boards supporting on fillets are provided and hallows space between the floorboards and the insulating boards is filled up with the pugging plaster.

(ii) **Trimming:** When openings are to be provided in wooden floors, it is clear that bridging joists will not rest on the walls. In such cases, the process of trimming is required. Trimming joists support one or two trimmer joists to which trimmed joists are fixed. The trimming joists and trimmer joists have

slightly greater section than bridging joists Fig. 12.2 shows a wooden floor with stair well.

- (iii) ***Use of stell sections:*** Binders and girders of wooden floor can be replaced by mild rolled steel joists. The only precaution to be taken in this case would be to encase the R.S.J. by concrete so as to prevent rusting of R.S.J. The use of steel section makes the floor light and economical.
- a) **Basement or ground floor of timber:**

In auditorium, to carry out dances or dramas timber floors are constructed on ground floor. Sleeper walls, which may be of one-half brick or one brick thickness, are constructed at centre to centre distance of 1.20m to 1.80m. Wall-plates are provided along the wall as well as along the sleeper walls and they reduce the spans of the building joists and serve as end supports for the bridging joists. On wall-plates rest the ends of bridging joists, which are usually provided at a centre to centre distance of about 30 cm. Finally, floor boards are provided to finish up the floor. The details are as shown in fig 12.2.

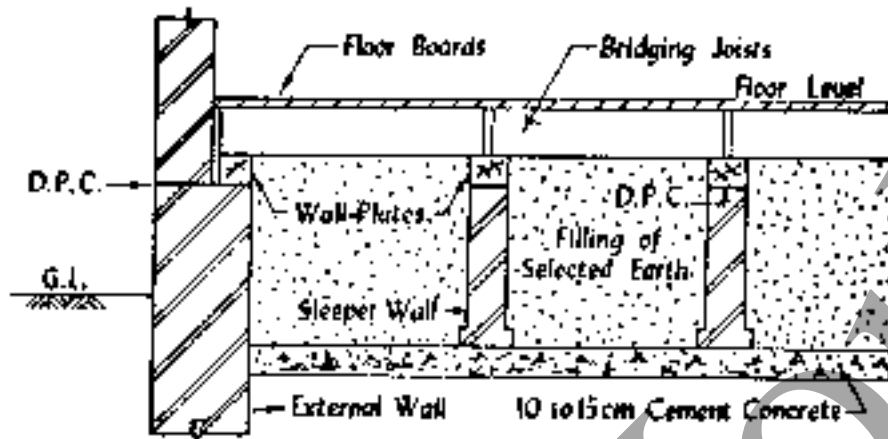

Fig 12.2. Basement or ground floor of timber

b) **Single Joist timber floor:**

These floors consist of single joist, which are placed below the floorboards. The joists are usually placed at a centre to centre distance of 30cm to 45cm. The joists are supported on wall-plates at their ends. A space of about 50mm is kept for the circulation of air as shown in fig 12.3. Single joist timber floor can be adopted for a maximum span of about 3.6m. When the span of joist exceeds 2.4m, it becomes necessary to strengthen the joist by providing bearing bone strutting. In this arrangement, inclined timber pieces are firmly fixed between the joists and the ends of these struts are nailed to the joist. At the end, wedges are provided between the wall and the joists.

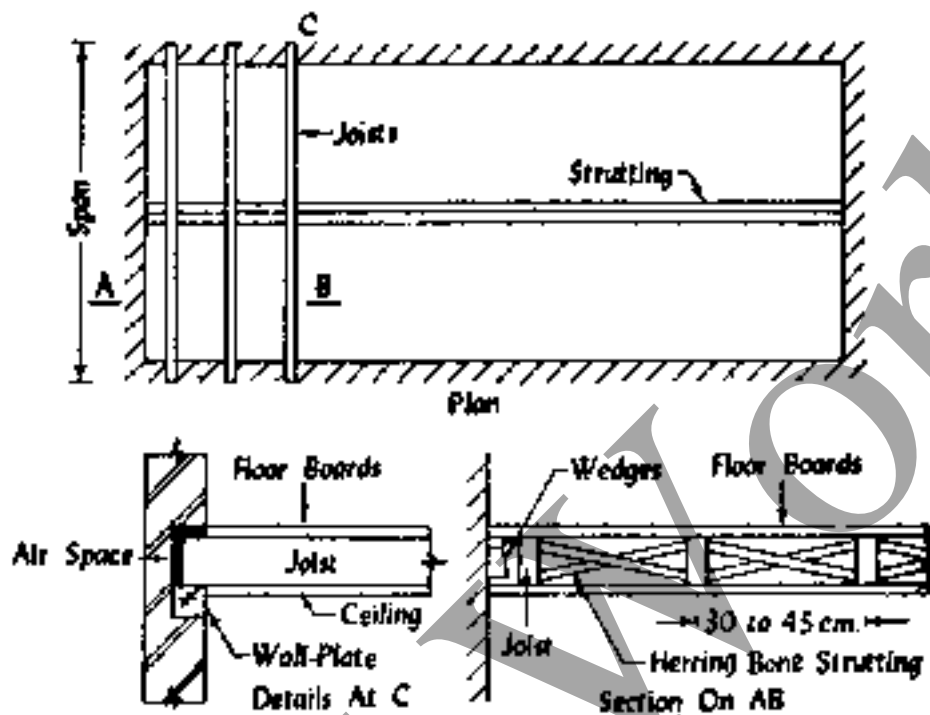
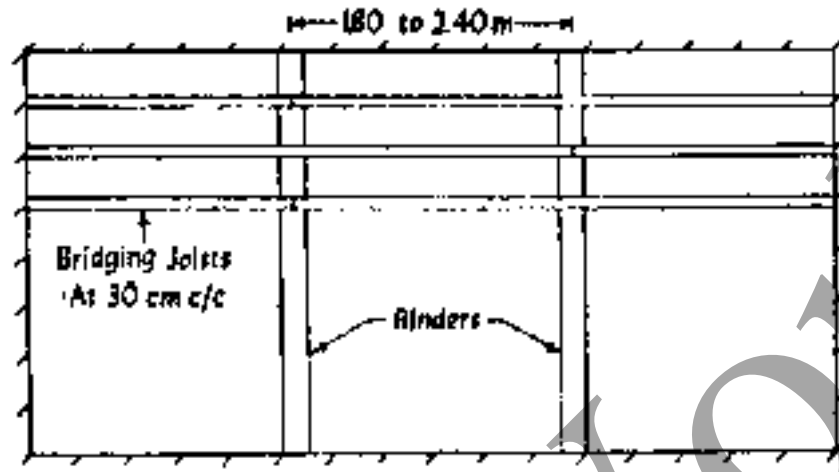

Fig 12.3 Details of single joist timber floor

c) **Double joist timber floors:**

In this type of floors, intermediate supports known as binders, are provided for bridging joists. Binders are generally placed at a centre to centre distance of 1.80m to 2.40m as shown in fig 12.4. The ends of binders rest on wooden or stone blocks. Double joist timber floors are stronger than the single joist timber floors. They prevent the passage of sound in better way and they are suitable for spans of 3.60 to 7.50m. This type of floors has following disadvantages.

- (i) The weight of floor is thrown on few points in a wall.
- (ii) Depth of floor is increased by the use of binders and accordingly height of the room is decreased.



Plan of double joist timber floor

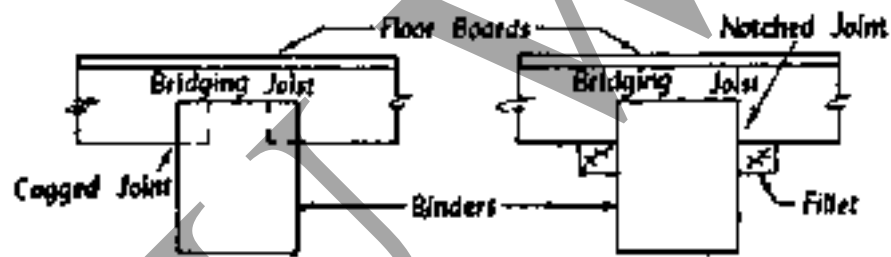

Methods of fixing binders with joists

Fig 12.4

d) **Framed or triple joist timber floor:**

In this type of floors, intermediate supports, known as girders, are provided for the binders. Thus, this type of floor consists of girders, binders, bridging joists and floor boards as shown in fig 12.5. Girders are generally placed at a centre to centre distance of 3 metres. Binders are staggered and connected to girders by tusk and tenon joints. Alternatively, the ends of binders are supported on the iron stirrups, which are fixed to

the girders. The ends of girders rest on walls on stone or concrete templates. This type of timber floor is suitable for spans greater than 7.50.

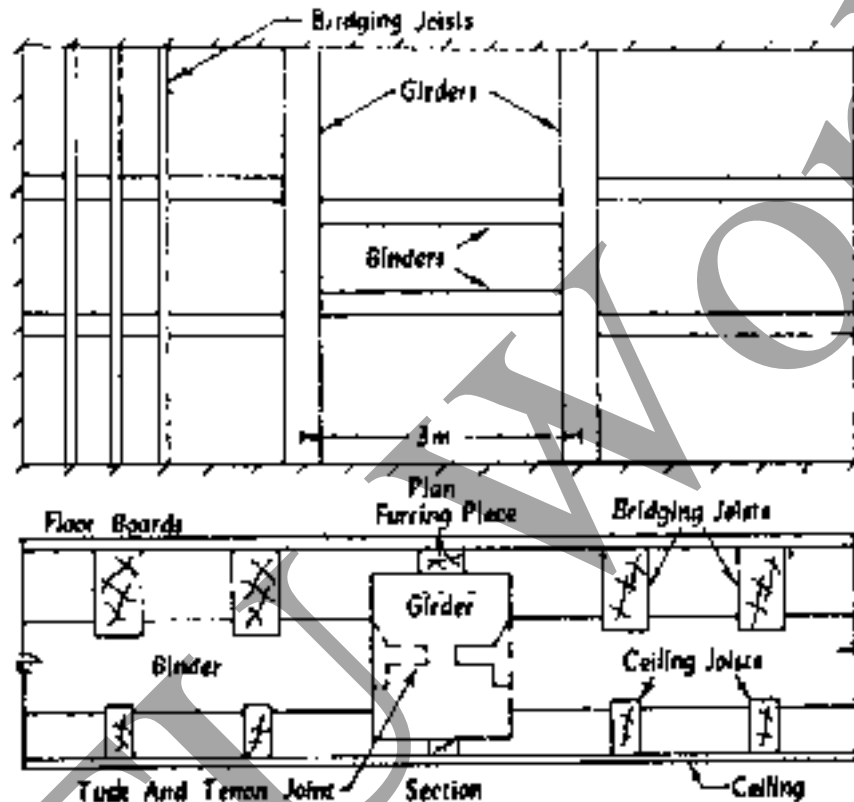

Fig 12.5 Details of framed timber floors

II Composite Floors:

Floors composed of more than one material are known as composite floors and they found to possess the following advantages.

- (i) Resist fire and sound in better way than timber floors
- (ii) Better hygienic because can be easily cleaned
- (iii) Adopted for greater spans.

Floors

Page 201

The following are the types of composite floors

- (a) Double flag stone floors
- (b) Filler Joists floors
- (c) Jack arch floor
- (d) R.C.C. floors
- (e) Hallow block and rib floors

a) Double flagstone floors:

In this type of floors, flagstones are used in two layers as shown in fig 12.6. If span is about 4m, only rolled steel joists are provided and span exceeds 4m, a framework consists of rolled steel beams and joists is formed. Steel beams are placed at a distance of about 3m centre to centre and joists are placed at right angles to beams. Flagstones of about 40mm thickness and of suitable width are fixed on the lower flanges and upper flanges. The joints of top layer of flagstones are finished in a better way to give a nice appearance. Filling of selected earth or concrete is done in the space between the two layers of the flagstones.

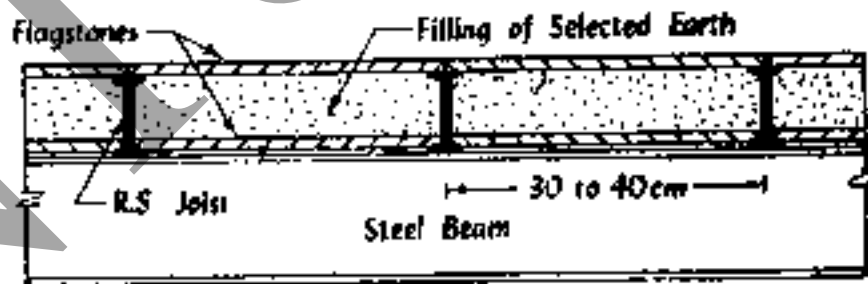

Fig 12.6 Double Flagstone floor

b) Filler Joist floors:

In this type of floors, small sections of rolled steel joists are placed in concrete, this joists may either rest on wall or on steel beam as shown fig 12.7. The joists act as a reinforced and are spaced at a centre to centre distance of 60cm to 90cm. Concrete should completely surround the rolled steel / joists and beams.

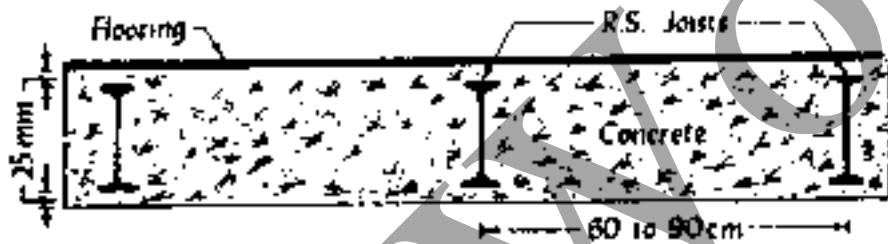

Fig 12.7 Filler Joist Floor

c) Jack arch floors:

In this type of floor, brick arches or cement concrete arches are constructed and these arches rest on the lower flanges of mild steel joists. The joists in turn rest either on wall or on beam. The joists are placed at a distance of about 80cm to 120cm center to center. The rise of arch should be 10cm to 20cm. and the minimum depth of concrete at the crown should be 15cm. The only disadvantage of this floor is that it does not give plain ceiling surface as shown in the fig 12.8. (a & b)

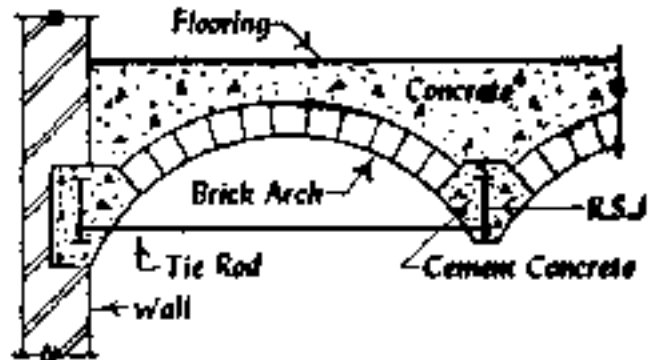

Fig 12.8 (a) Brick Jack arch floor

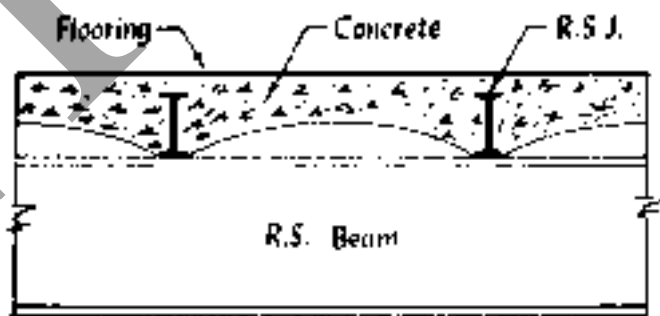
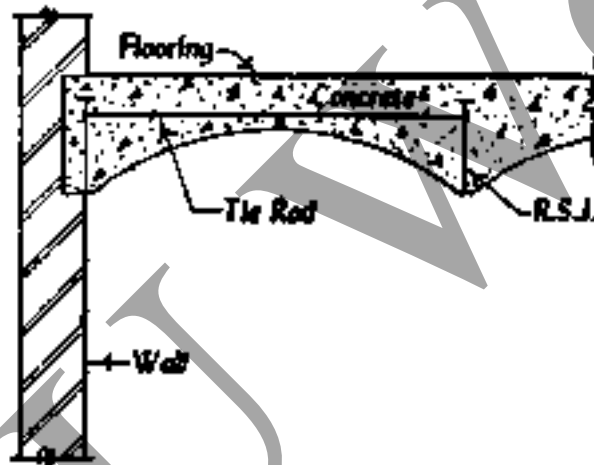

Fig 12.8 (b) Concrete jack floor

- d) **R.C.C Floor:** In this type of floors steel bars and concrete are used to form a floor. This type of floor is widely used in modern construction. The slab and beam are designed as per loading coming on the floor and proper reinforcement is placed at a suitable place. In case of R.C.C. slab thickness varies from 80mm to 150mm and the main reinforcement is generally in the form of mild steel bars of diameter varying from 9mm to 12mm as shown in the fig. 12.9.

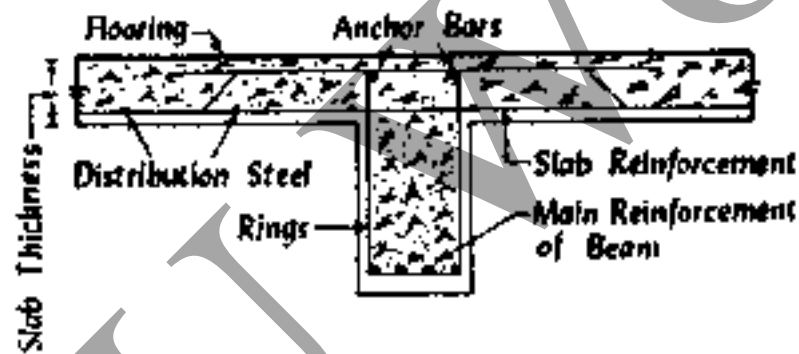

Fig 12.9 R.C.C. Floor

The reinforced concrete may be cast-in-situ or pre-cast, the former being very common. R.C.C. floors are less costly, durable, easy to construct and fire-proof. However, they are likely to transmit sound. In any case R.C.C. floors are fast replacing other types of floors.

- e) **Hallow Block and Rib Floors:** In this type of floors, hallow blocks of clay or concrete are used to reduce the total weight of the floor. In one form, the blocks are placed 10cm apart and in this space, mild steel bars are placed as shown in the

Floors**Page 205**

fig 12.10.A minimum cover of 80mm is kept at the top. Suitable flooring at the top and sealing finish are provided. The blocks are provided with rough or grooved surface so that they can develop enough bond with the concrete. This type of floor is economical, fire proof, sound proof and light in weight. If properly designed, this type of floor can even be used to carry heavy loads.

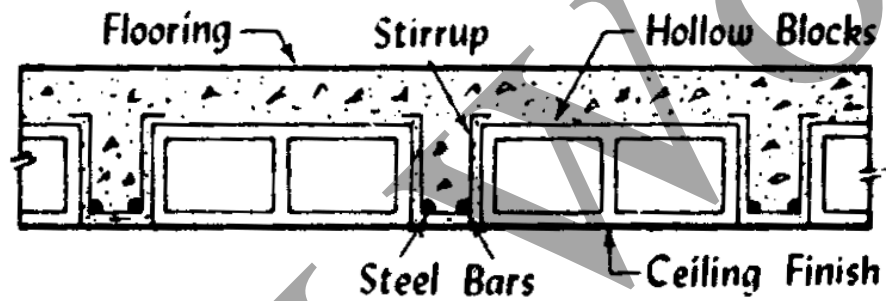

Fig 12.10 Hallow Block and Rib floor

* * *

SYNOPSIS

1. In order to sub-divide the portion between the plinth level or basement level and roof level, solid constructions are known as floors.
2. The floors are classified into
 - (i) Timber floors
 - (ii) Composite floors
3. The timber floors are divided into
 - (i) Basement or ground floor of timber
 - (ii) Single joist timber beam
 - (iii) Double joist timber beam
 - (iv) Framed or triple joist timber beam
4. The composite floors are the following
 - (i) Double flag stone floors
 - (ii) Filler joists floors
 - (iii) Jack arch floor
 - (iv) R.C.C. floors
 - (v) Hollow block or rib floors

Floors

Page 207

SHORT ANSWER QUESTIONS

1. Define floor
2. What are the types of floors?
3. Name the types of timber floors
4. What are the advantages of composite floors?
5. Name the types of composite floors.

ESSAY TYPE QUESTIONS

1. Explain different types of timber floors briefly
2. Explain the following
 - a) double flag stone floors
 - b) jack arch floors
3. Explain the construction of composite floors briefly
4. Explain the following
 - a) R.C.C. floor
 - b) Hollow block and rab floors

* * *

CHAPTER – 13**ROOFS**

A roof is defined as the uppermost part of a building which is constructed in the form of a frame work to given protection to the building against rain, heat, snow, wind etc. A roof basically consists of structural elements provided at the top of building for the support of roof coverings.

Following are the requirements of well planned roof:

- (i) It should be durable against the adverse effects of various agencies such as wind, rain, sun etc.
- (ii) It should grant the desirable insulation against sound and heat.
- (iii) It should be structurally stable and sound, it should be capable of taking the loads likely to come over it.
- (iv) It should be well-drained
- (v) It should have efficient water-proofing arrangement.

13.1 Types of roofs-Methods of construction:

The roofs classified into the following three categories;

- (i) Pitched roofs
- (ii) Flat roofs
- (iii) Curved roofs

- I. **Pitched roofs:** A sloping roof is known as pitched roof as shown in the fig 13.1. The technical terms in connection with the pitched roof are given below

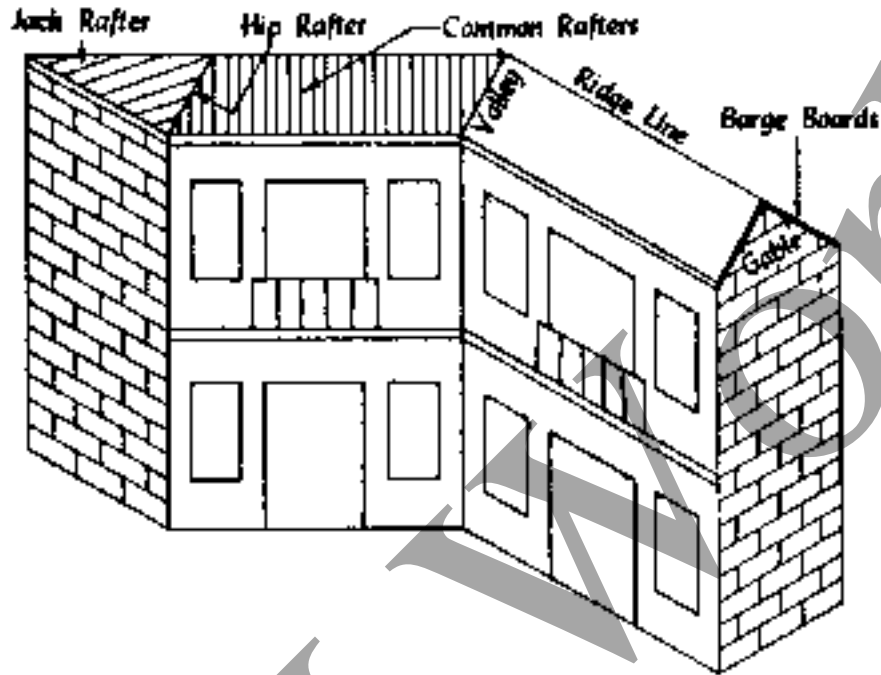

Fig 13.1 Building with pitched roof

- (i) **Barge Boards:** Wooden planks or boards which are fixed on the gable end of the roof
- (ii) **Battens:** Thin strips of wood which are fixed on rafters or ceiling to support the roof ceiling.
- (iii) **Cleats:** Small blocks of wood which are fixed on truss to prevent the sliding of purlins.
- (iv) **Dragon beam:** The diagonal piece of wood which is laid across the corner of the wall.

- (v) **Eaves:** The lower edge of a roof which are resting upon or projecting beyond the supporting walls are known as eave as shown in the fig 13.2
- (vi) **Gable:** The triangular upper part of a wall formed at the end of a pitched roof is known as gable.
- (vii) **Hip:** The angle formed at the intersection of two roof slopes is known as hip.
- (viii) **Pitch:** The inclination of sides of a roof to the horizontal plane is known as pitch, expressed in degrees or as a ratio of rise to span.
- (ix) **Purlins:** The wooden pieces which are placed horizontally on principal rafters to carry the common rafters are known as purlins.
- (x) **Rafters:** There are the pieces of timber which extend from the eaves to the ridge
 - a) **Common rafters:** These are the intermediate rafters, which give support to the roof coverings a shown in the fig 13.2.
 - b) **Hip rafters:** Which provided at the junction of two roof slopes
 - c) **Jack rafters:** Any rafters, which is shorter than common rafters is known as Jack Rafters.
 - d) **Principal rafters:** These are the inclined members of a truss

Roofs

Page 211

- (xi) **Ridge:** A wooden piece provided at the ridge line of a sloping roof is known as ridge or ridge board or ridge piece
- (xii) **Span:** The horizontal distance between the internal faces of walls or supports is known as span or clear span.
- (xiii) **Template:** A bidding block generally provided at the end of a truss. This block is known as template and it helps in spreading load over a large area. A template may be of wood or stone or R.C.C.
- (xiv) **Verge:** The edge of a gable, running between the eaves and ridge is known as a verge
- (xv) **Valley:** When two roof surfaces meet together and form an internal angle, a valley is formed
- (xvi) **Wall-plate:** These are long wooden members which are embedded on top of walls to receive the common rafters

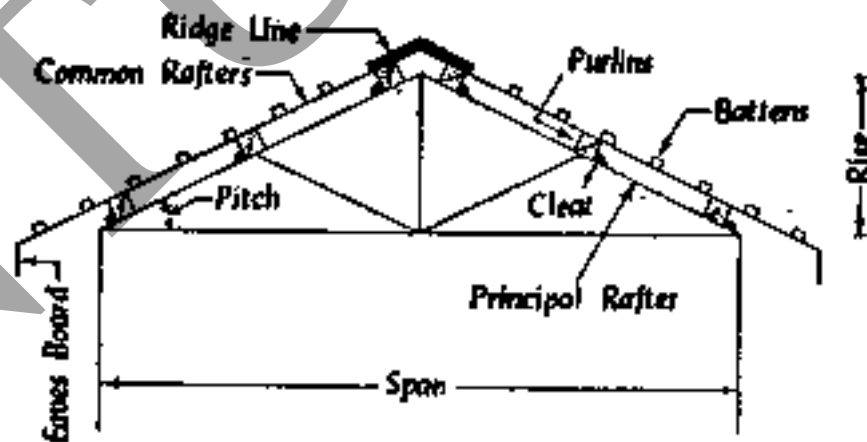

Fig 13.2 Truss

Types of pitched roofs:

- (i) Single roof
- (ii) Double or purlin roof
- (iii) Trussed roofs

(i) **Single roof:** In this type of roofs, common rafters are provided to each slope without any intermediate support. The following are the varieties of single roof.

- a) Lean to roof
- b) Couple roof
- c) Couple close roof
- d) Collar beam roof

a) **Lean to roof:** It is the simplest form of a pitched roof and it is known as pent roof or Aisle roof. In this type of roof, one wall is carried up sufficiently higher than the other to give necessary slope to the roof. A lean-to roof is generally used for sheds, out-houses attached to main buildings verandah etc. This is suitable for a maximum span of 2.40m as shown in fig 13.3.

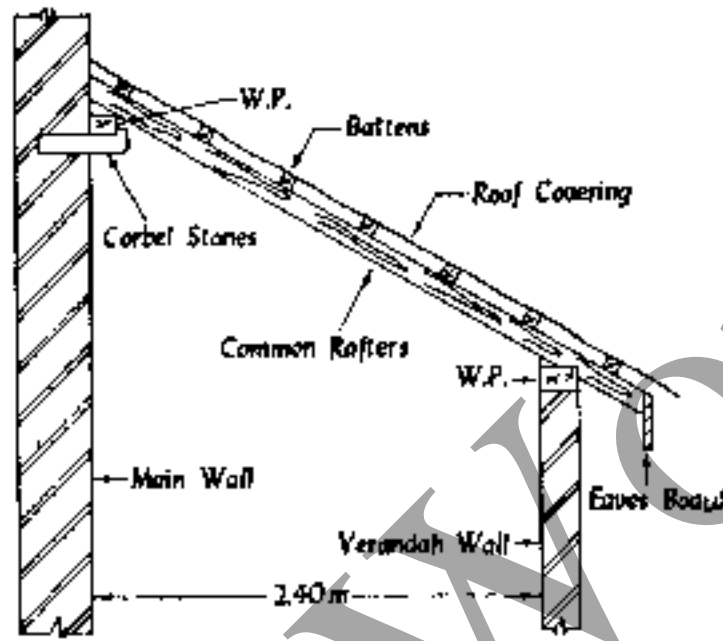

Fig 13.3 Lean-to roof

- b) **Couple roof:** In this type of roof the common rafters slope upwards from the opposite walls and they meet on a ridge piece in the middle as shown in the fig 13.4. A couple roof is suitable for spans upto about 3.6m.

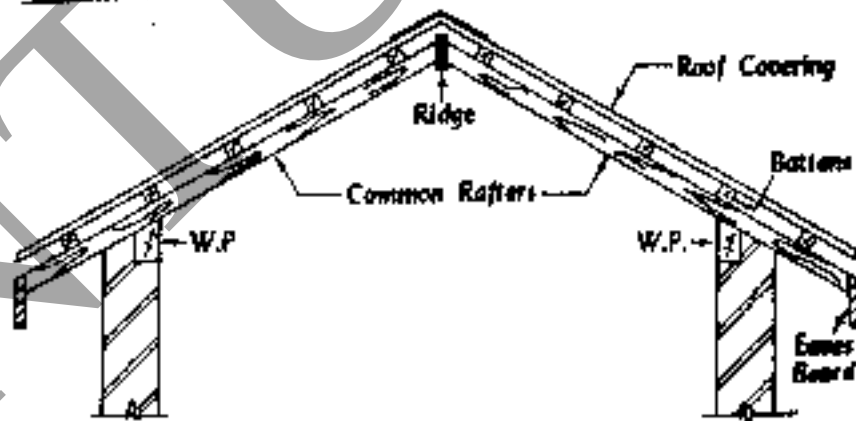

Fig 13.4 Couple roof

- c) **Couple close roof:** This roof is just similar to couple roof except that the legs of the common rafters are connected by a tie beam as shown in the fig 13.5. The tie beam prevents the tendency of rafters to spread out and thus danger of overturning of the walls is avoided. This roof can be adopted economically upto the span of 4.2m.

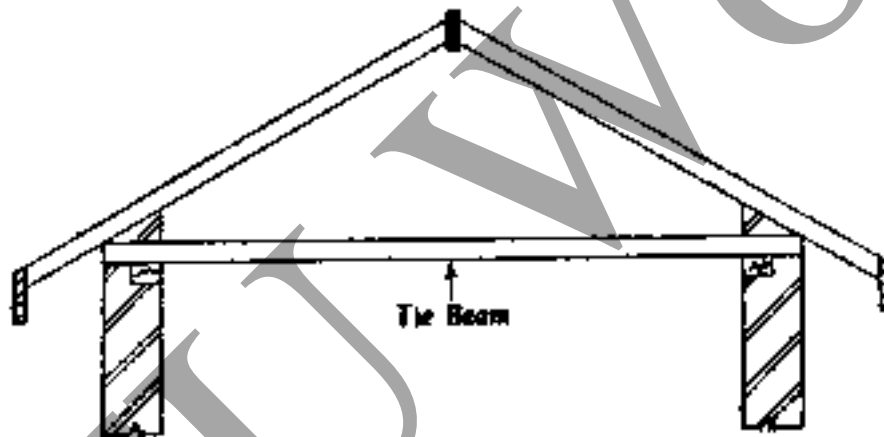

Fig 13.5 Couple close roof

- d) **Collar beam roof:** The tie beam is raised and placed at a higher level as shown in fig 13.6 known as collar or collar beam. This beam roof is adopted to economise the space and to increase the height of a room. This roof can be adopted upto a maximum span of 4.8m.

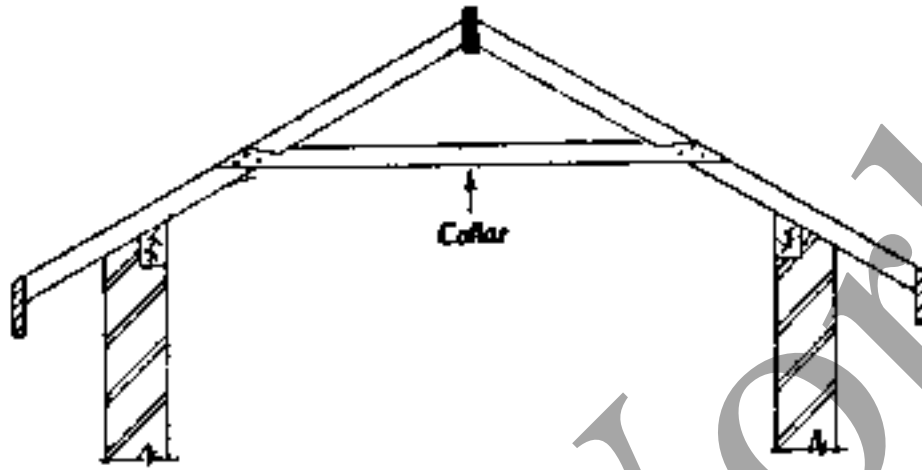

Fig 13.6 Collar beam roof

- (i) **Double or purlin roofs:** When the span exceeds 2.4m, the necessary size for the rafters becomes uneconomical. Hence in order to reduce the size of rafters, intermediate supports called purlins are introduced under the rafters as shown in fig 13.7. This roof can be adopted economically upto 4.8m.

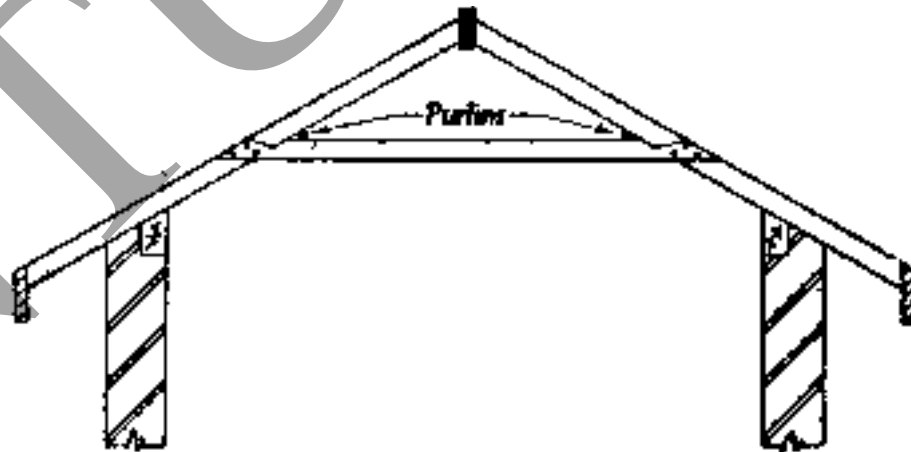

Fig 13.7 Double or Purlin roof

(ii) **Trussed roofs:** When the span exceeds 4.8m and when there are no inside supporting walls or partitions for purlins, framed structure known as trusses are on the roof, position of cross walls, span and material of the truss. The spacing is 3m for wooden trusses. Trusses carry the ridge piece and purlins on which the common rafters rest. Some of the usual forms of roof truss are given below.

- a) King-post truss
- b) Queen post truss
- c) Mansard truss
- d) Truncated truss
- e) Bel-fast truss
- f) Steel trusses
- g) Composite trusses

a) **King post truss:** In this type of truss, the central post known as king-post forms support for the tie beam. The inclined members, known as struts, prevents the principal rafters from bending in the middle. A king-post truss suitable for roofs of span varying from 5 to 8 m as shown in fig 13.8.

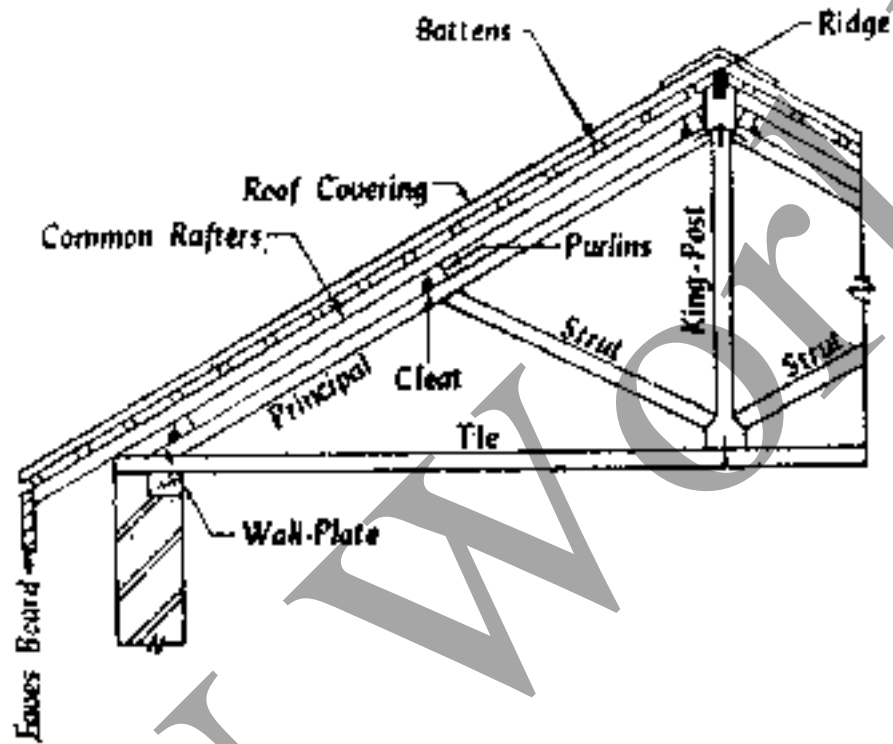

Fig 13.8 King post truss roof

- b) **Queen post truss:** This truss differs from a king-post truss in having two vertical members known as queen posts. The upper ends of the queen posts are kept in position by means of a horizontal member known as straining beam. Additional purlins are supported on the queen posts. A queen post truss is suitable for roof spans varying 8 to 12 m as shown in fig 13.9.

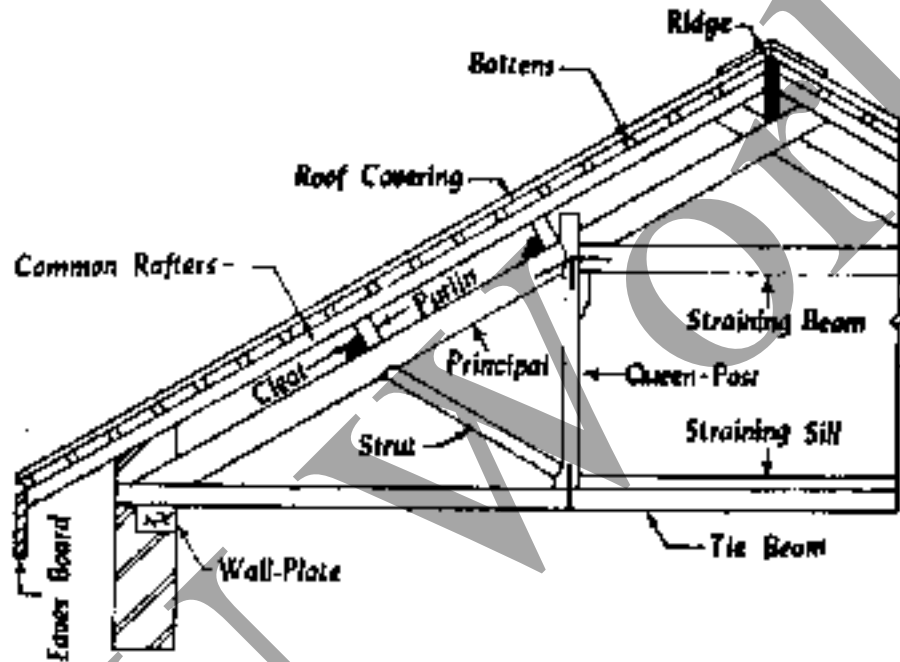

fig 13.9 Queen post truss

- c) **Mansard truss:** this is a combination of king post and queen post trusses. Lower queen post & upper king post trusses. Use of mansard trusses results in the economy of space and room may be provided in the room as shown in the fig 13.10.

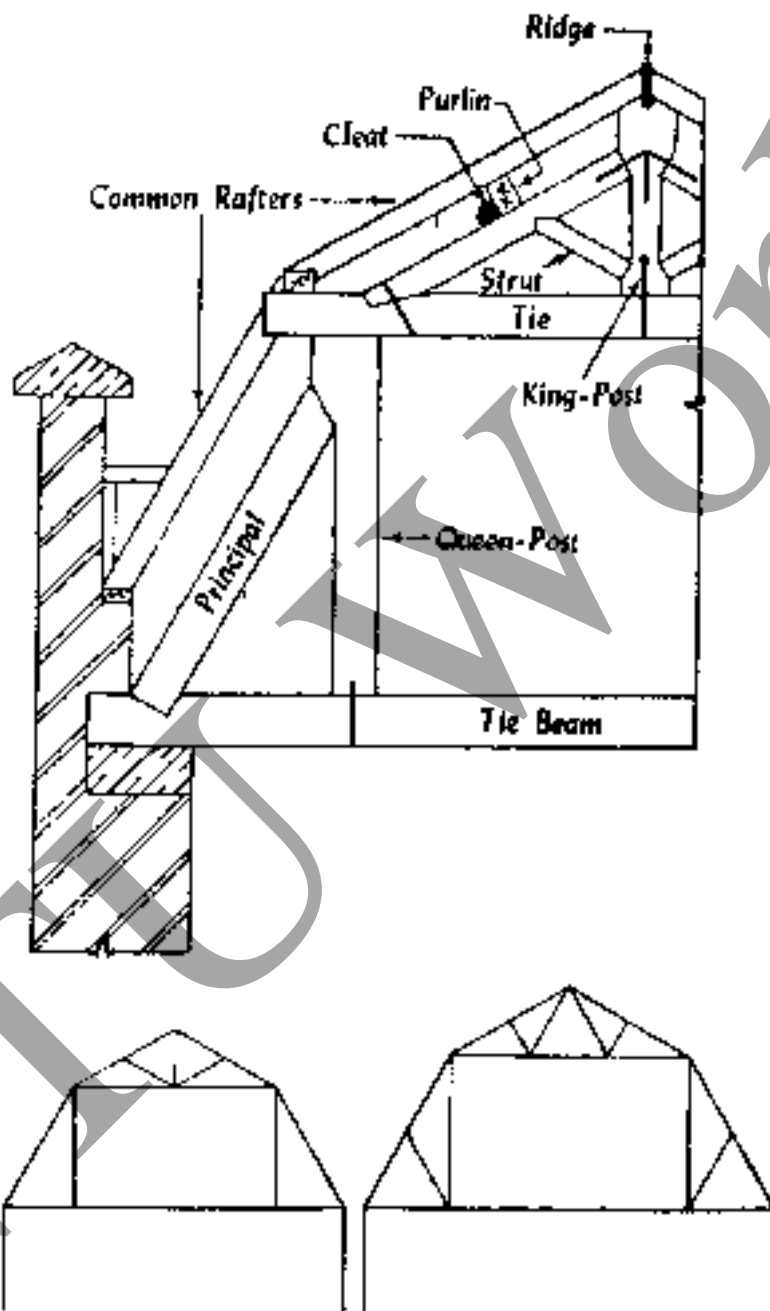

Fig 13.10 Mansard truss

- d) **Truncated truss:** This is similar to mansard except that the top is finished flat as shown in fig 13.11.

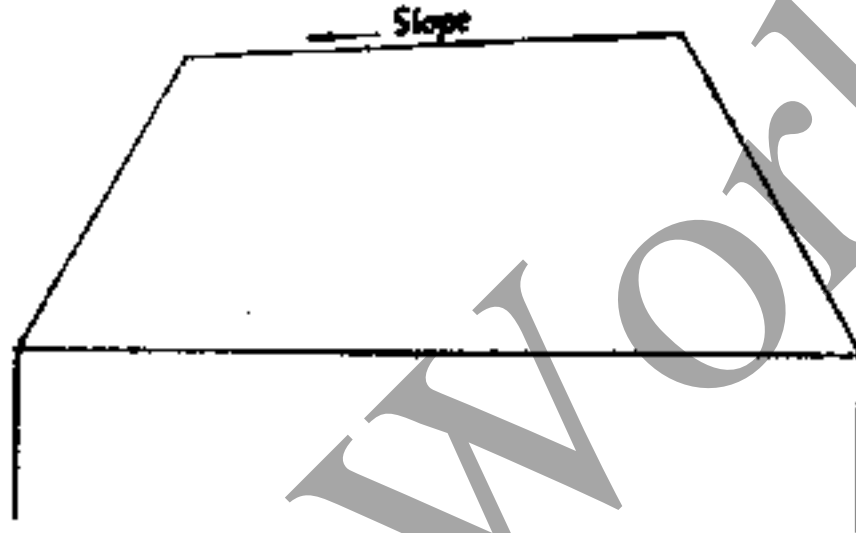
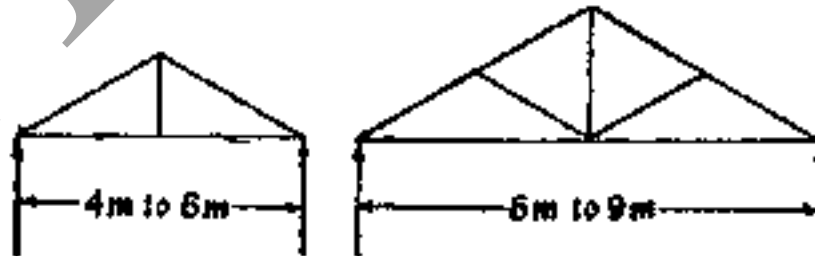
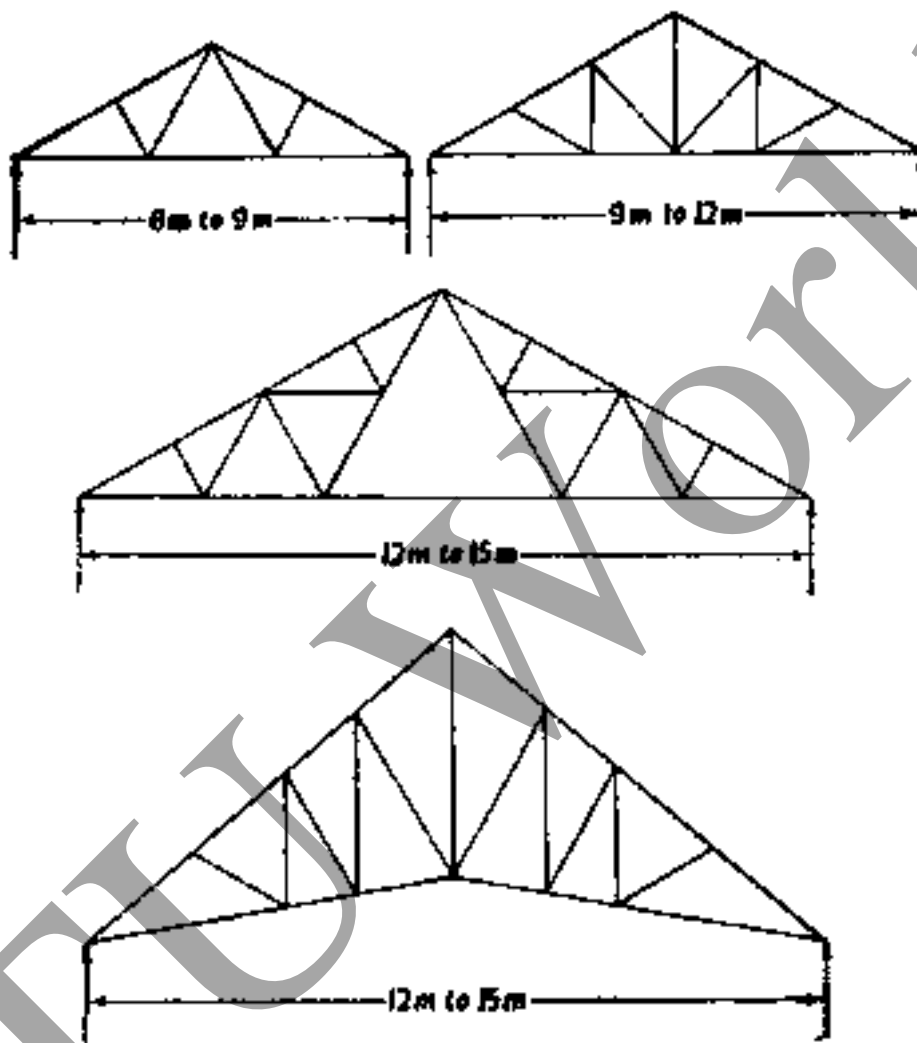

Fig 13.11 Truncated truss

- e) **Steel trusses:** For spans greater 12m, it becomes economical to use steel trusses. For smaller spans, steel trusses consists of angles riveted or welded together through plates known as gusset plates. As steel resists both compression and tension stresses, the design of steel truss is simplified various types of steel trusses are shown in fig 13.12.





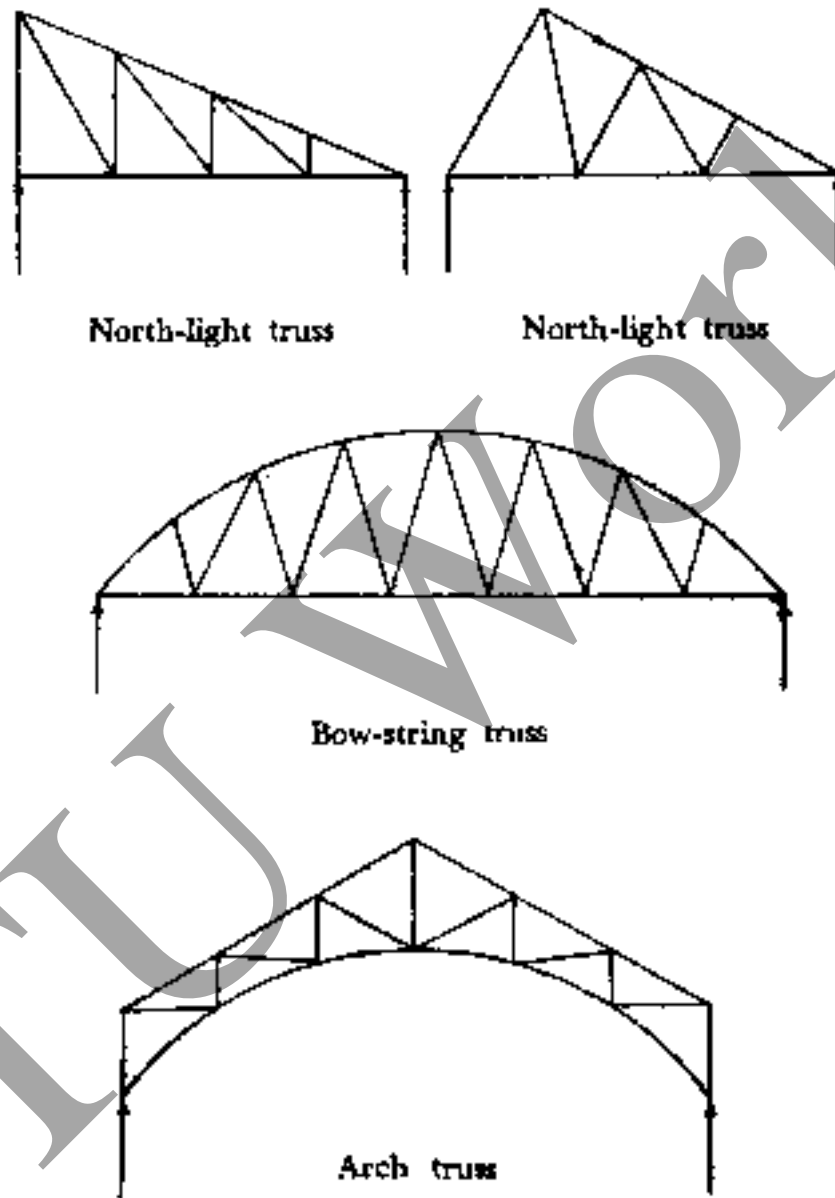

Fig 13.12 Steel trusses

- f) **Composite stress:** This truss composed of wooden members and steel. Steel members resist tension. A composite truss is light and economical as shown in the fig 13.13.

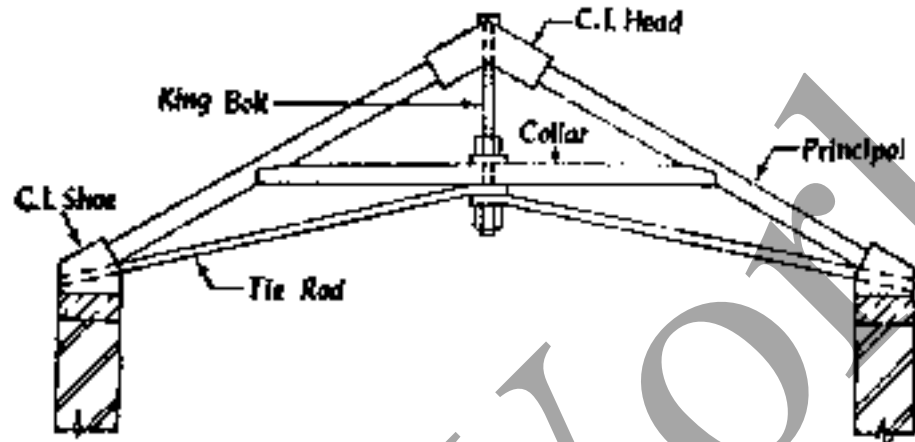

Fig 13.13 Composite stress

The factors should be considered before selecting the type of roof covering for pitched roof

- (i) Climate of the locality
- (ii) Nature of the building
- (iii) Initial cost and maintenance cost
- (iv) Resistance to fire and heat
- (v) Special features of the locality.

II Flat Roofs: A roof which is nearly flat is known as flat roof. It should be noted that no roof can be laid perfectly level. The roof must slope in one direction or the other to cause rain water to flow off rapidly and easily. The construction of flat roof is same as that of floors except that the top surface is made slightly.

Sloping in case of flat roofs. The types of flat roofs commonly used are

1. Madras terrace roof
2. Bengal terrace roof

1. Madras Terrace Roof:

Procedure of construction:

1. Teak wood joists are placed on rolled steel joists with a furring piece between the joists and rolled steel joists. The furring is placed sloping and gives necessary slope to the flat roof
2. A course of specially prepared terrace bricks of 150x75x25mm is laid diagonally across the joists with lime mortar
3. After the brick course, has set, a course of brick bat concrete of 75mm thick with 3 parts of brick bats, one part of gravel and sand and 50 percent of lime mortar by volume is laid.
4. The concrete is well rammed for three days and allowed to set
5. Flat tiles are laid over the layer of concrete of thickness 50mm
6. Finally, the surface of roof is finished with three coats of plaster given a slope of 1 in 30.
7. As this type of flat roof is widely used in madras state, it is known as madras terrace roof as shown in fig 13.14.

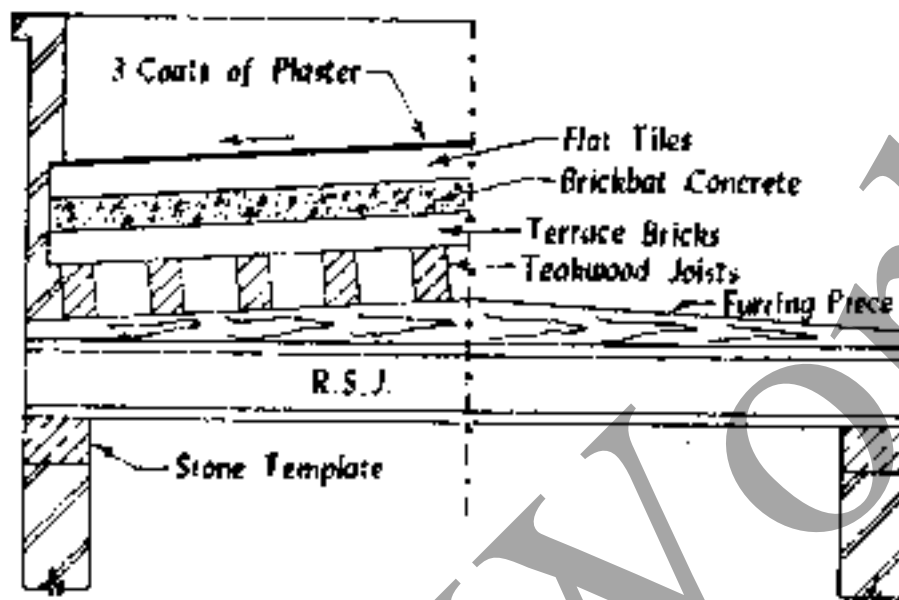

Fig 13.14 Madras Terrace Roof

2. Bengal terrace roof:

Procedure of construction:

1. Rafters are placed, with a slight inclination, at 30cm to 50cm c/c. one end of the rafters is inserted into the main wall to a depth of 20cm and its other end is supported on a verandah wall.
2. Battens are placed at right angles to the rafters at a centre to centre distance of about 15cm
3. A course of flat tiles is then laid in mortar over the battens.
4. Finally, the surface of the roof is finished in any one of the following methods
 - (i) Two or more courses of flat tiles may be laid and the surface of roof is rubbed and polished with two or three coats of plaster

- (ii) A layer of jelly concrete of 40mm thick may be laid over the first course of files. On this layer of concrete, another course of flat tiles is laid and the surface of roof is rubbed and polished with two or three coats of plaster
5. As this type of roof is mainly used in Bengal state to cover verandahs, it is known as Bengal Terrace roof as shown in fig 13.15.

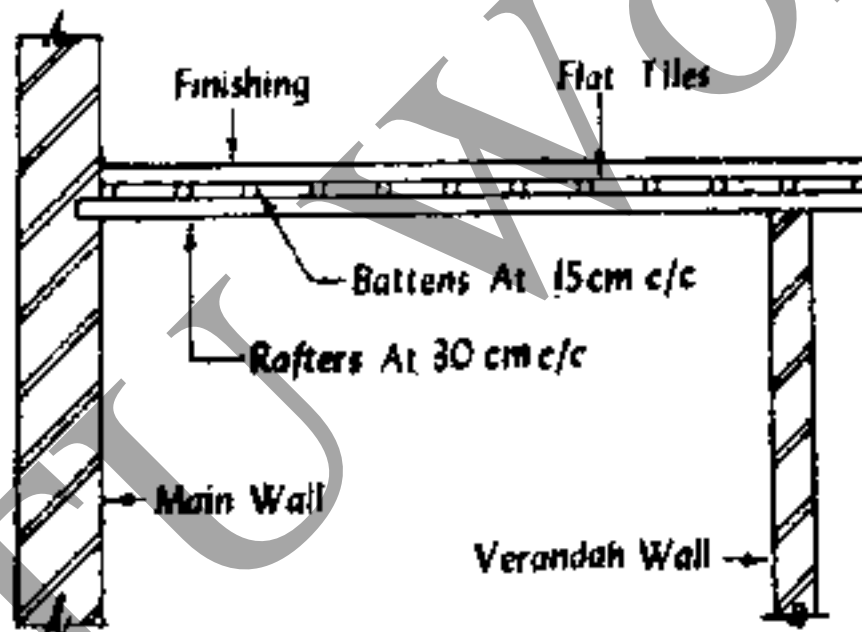

Fig 13.15 Bengal Terrace roof

Advantages of flat roofs:

- (i) The construction of roof is simplified
- (ii) It is easier to make a flat roof fire-proof than a sloping roof

Roofs

Page 227

- (iii) The roof are can be utilized as roof garden, drying yards and conveniently be used for sleeping in hot season.
- (iv) The construction of work of upper floors can be easily started where as pitched roof, the entire roof is to removed and is to be replaced by a new floor under such circumstances
- (v) Flat roofs is found to be economical than pitched roof.

Disadvantages

- 1) Flat roofs cannot be used for long spans without introduction of intermediate pillars and beams
- 2) Cracks are developed on the surface of the roof due to the variation in temperature
- 3) Pockets of water are formed on the surface of the roof if slope is not sufficient and leads to leakage of roof
- 4) Flat roofs are not suitable, where rainfall is heavy
- 5) The dead weight of flat roof is considered and hence it proves to be more expensive, Initial cost is higher than pitched roof.

III Curved roofs: These are the just the modifications of pitched roofs and are frequently employed in modern age to cover large areas shed/roofs and domes are the varieties of curved roofs. They are useful for big structures such as factories, monumental works etc curved roofs may be constructed of timber or R.C.C. the latter material being very common now-a-days. They are two common forms of a shell roof

- i) A north-light shell roof
- ii) A barrel vault shell roof are as shown in fig 13.16 & 13.17

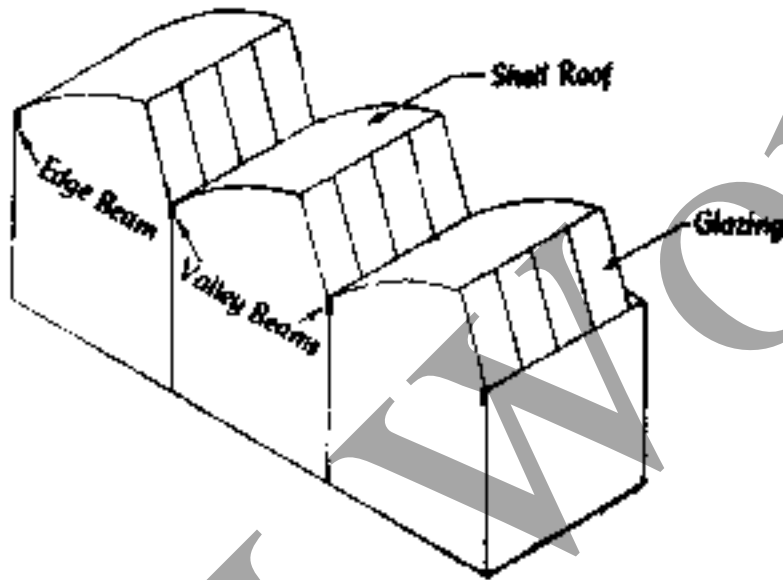

Fig 13.16 North-light shell roof

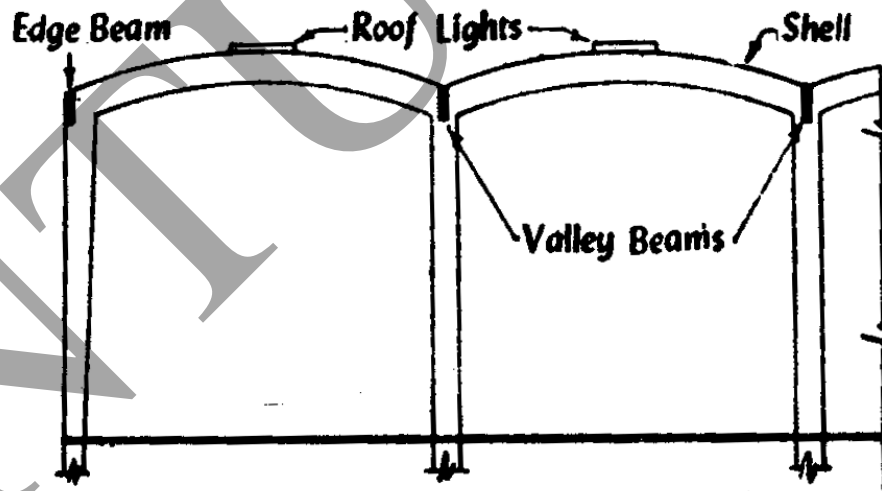

Fig 13.17 Barrel vault shell roof

A dome is a round vault forming a roof. It is useful when roof is to be provided on circular brick work or regular polygon shaped walls .

Roofs

Page 229

Curved roofs afford pleasing appearance and due to arch action, the stresses are considerably reduced which results in thin sections for a curved roof.

Procedure of construction

- (i) Pre-cast units of cement concrete tiles of size 70 x 70cm with a uniform minimum thickness of 20mm in the form of domes with a rise of about 50mm are used
- (ii) Pre-cast units of R.C.C. 1:2:4 beams are prepared as per design usually 90mm deep and 130mm wide as per design usually 90mm deep and 130mm wide
- (iii) The beams are suitably laid across the supporting walls
- (iv) The tiles are placed in position after spreading some mortar on the edges of beams. The minimum bearing of tiles on beams should be 25mm and that on walls should be 50mm to 70mm
- (v) The haunches between the humps of tiles are filled up with cement concrete of proportion 1:2:4
- (vi) Suitable water-proofing treatment to the roof is given at the top. The roof thus exhibits a flat surface at the top and curved surface at bottom.

Advantages

1. It can be constructed in short time
2. It does not require skilled supervision
3. It is cheap in construction
4. It requires less frame work

* * *

SYNOPSIS

1. A roof is defined as uppermost part of a building which is constructed in the form of a frame work to give protection to the building against rain, heat, snow, wind etc
2. A well planed roof requires following requirements
 - (i) Durable against adverse effects
 - (ii) Insulation against sound and heat
 - (iii) Stable
 - (iv) Well drained
 - (v) Efficient water-proofing
3. The types of roofs are
 - (i) Pitched roofs
 - (ii) Flat roofs
 - (iii) Curved roofs
4. A sloping roof is known as pitched roof are the following types
 - (i) Single roof
 - (ii) Double or purlin roof
 - (iii) Trussed roof
5. A single roof common rafters are provided to each slope without any intermediate support is the following types.
 - (i) Lean to roof
 - (ii) Couple roof
 - (iii) Couple close roof
 - (iv) Collar beam roof
6. When the span exceeds 2.4m, intermediate supports called purlins are provided in double or purlin roof upto 4.8m.

Roofs**Page 231**

7. When the span exceeds 4.8m and when there are no inside supporting walls or partitions for purlins, framed structure known as truss of following types
- (i) King post truss
 - (ii) Queen post truss
 - (iii) Truncated truss
 - (iv) Be-fast truss
 - (v) Steel truss
 - (vi) Composite truss
8. A roof which is nearly flat is known as flat roof commonly used flat roofs are
- (i) Madras terrace roof
 - (ii) Bengal terrace roof
9. Curved roof are the just modified of pitched roofs to cover large areas
- Ex: shell roofs, dome roofs.

SHORT ANSWER QUESTIONS

1. Define roof.
2. What are the categories of roof?
3. Define common rafter.
4. What are the types of pitched roofs?
5. What are the advantages of flat roofs?
6. What are the advantages of curved roof?
7. Name the different types of single roofs.
8. What are the types of trussed roofs?
9. What is king post and queen post trusses?

ESSAY TYPE QUESTIONS

1. What are the requirements of a well planned roof?
2. Explain the classification of roofs briefly.
3. Explain types of single roofs.
4. Explain king post and queen post truss.
5. Explain the construction of flat roof of madras terrace roof
6. Explain the construction of flat roof of Bengal terrace roof.
7. Explain the advantages and disadvantages of flat roofs.
8. Explain briefly about curved roofs.

* * *

CHAPTER 14**DAMP PROOF AND FIRE PROOF CONSTRUCTION**

Damp prevention and fire protection are the chief requirements to ensure the safety of buildings against dampness and fire respectively. The sources, effects, techniques and methods of damp prevention, materials used for damp-proofing (D.P.C) damp-proofing treatments in buildings, treatment of dampness are discussed under damp proof chapter.

14.1 Sources of dampness(causes)

Dampness in building in generally due to one or more of the following causes

- (i) Faulty design of structure
- (ii) Faulty construction or poor workmanship
- (iii) Use of poor materials in construction

These cause give rise to an easy access to moisture to enter the building from different points, such as rising of moisture from ground, rain penetration through walls, roofs and floors etc. The moisture entering the building from foundation and roofs, travels in different directions further under the effects of capillary action and gravity respectively. The entry of water and its movements, in different parts of the building are positively due to the one or more of the causes listed above.

14.2 Effects of dampness:

The various effects caused due to dampness in buildings mainly results in poor functional performance, ugly appearance and structural weakness of the buildings.

1. A damp building creates unhealthy living and working conditions for the occupants
2. Presence of damp condition causes efflorescence on building surfaces which ultimately results in the disintegration of bricks stones, tiles etc and hence reduction of strength
3. It may result in softening and crumbling of plaster
4. It may cause bleaching and flaking of the paint which results in the formation of coloured patches on the wall surfaces and ceilings
5. It may result in the corrosion of metals used in the construction of buildings
6. The materials used as floor coverings such as tiles are damaged because they lose adhesion with the floor bases
7. Timber when in contact with damp condition, gets deteriorated due to the effect of warping, buckling and rolling of timber
8. All the electrical fittings gets deteriorated, causing leakage of electric current with the potential danger of a short circuit
9. Dampness promotes the growth of termites and hence creates unhygienic conditions in buildings

Damp Proof and Fire Proof Construction

Page 235

10. Dampness when accompanied by the warmth and darkness, breeds the germs of tuberculosis, neuralgia, acute and chronic neumatism etc which some times result in fatal diseases

14.3 Techniques and methods of damp prevention:

The following are the precautions to be taken to prevent dampness in buildings, before applying the various techniques.

1. The site should be located on high ground and well drained soil to safe guard against foundation dampness
2. All the exposed walls should be of sufficient thickness to safeguard against rain protection (minimum 30cm)
3. Bricks of superior quality free from defects should be used
4. Good quality cement mortar (1:3) should be used to produce definite pattern and perfect bond in the building
5. Cornices and string courses should be provided to through rain water away from the walls
6. All the exposed surfaces like top of walls, compound walls etc should be covered with water proofing cement plaster
7. Cavity walls are more reliable than solid walls in preventing the dampness

Techniques:

1. Use of damp proof courses
2. Water proof or damp proof treatments
3. Cavity walls or hollow walls

4. Guniting or shot concrete or shotcrete
5. Pressure grouting or cementation

1. Use of damp-proof courses (D.P.C.)

These are layers or membranes of water repellent materials such as bituminous felts, mastic asphalt, plastic sheets, cement concrete, mortar, metal sheets, stones etc which are interposed in the building structure at all locations wherever water entry is anticipated or suspected. The best location or position of D.P.C. in the case of building without basement lies at plinth level or structures without any plinth level, it should be laid at least 15cm above ground level. The damp proof course provided horizontally and vertically in floors, walls etc. In the case of basements, laying of D.P.C. is known as taking Fig 14.1 shows the D.P.C. treatment above ground level.

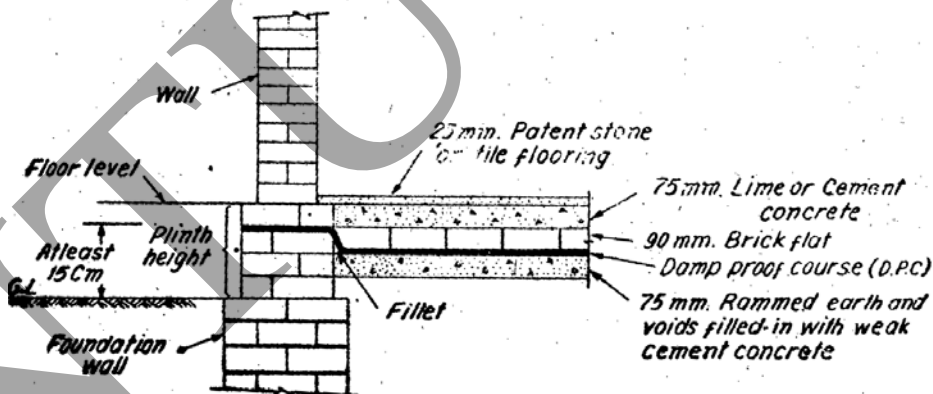

Fig 14.1 D.P.C. above ground level for new buildings

2. **Water proof surface treatments:** The surface treatment consists in filling up the pores of the material exposed to moisture by

Damp Proof and Fire Proof Construction

Page 237

providing a thin film of water repellent material over the surface (internal / external) . External treatment is effective in preventing dampness

Many surface treatments, like pointing, plastering, painting, distempering etc are given to the exposed surfaces and also to the internal surface . The most commonly used treatment to protect the walls against dampness is lime cement plaster (1:6) (1-cement, 6-lime) mix proportion. Generally employed as water proofing agent in surface treatments are sodium or potassium silicate. Aluminium or zinc sulphate, Barium Hydroxide and magnesium sulphate in alternate applications. Soft soap and alum also in alternate applications, unie and unseed oil; coal tar, bitumen, waxes and fats; resins and gums

Waxes and fats are not suitable in tropics as they melt with rise in temperatures

3. Integral damp-proofing treatments :

The integral treatment consists of adding certain compounds to the concrete or mortar during the process of mixing, which when used in construction acts as barriers to moisture penetration under different principles

- i) **Compounds like chalk**, talc, fallers earth etc have mechanical action principle (i.e.,) they fill the pores present in the concrete or mortar and make them dense and water proof

- ii) **Compounds like denser** and water proof sulphates, calcium chlorides etc work on chemical action principle (i.e.) they react chemically and fill the pores to act as water-resistant
 - iii) **The compounds like soaps**, petroleum, oils fatty acids compounds such as sterates of calcium, sodium ammonium etc work on the repulsion principle i.e., they are used as admixture in concrete to react with it and become water repellent
4. **Cavity walls or hallow walls:** A cavity wall consists of two parallel walls or leaves or skins of masonry separated by a continuous air space or cavity. The provision of continuous cavity in the wall per effectively prevent the transmission or percolation of dampness from outer walls or leaf to inner wall or leaf. The following are the advantages of cavity wall.
- (i) As there is no contact between outer and inner walls of cavity wall, possibility of moisture penetration is reduced to a minimum.
 - (ii) A cavity wall prevents the transmission of heat through wall.
 - (iii) A cavity wall offer good insulation against sound.
 - (iv) The cavity wall tends to reduce the nuisance of efflorescence.
 - (v) The cavity wall also provides benefits such as economy, better comfort and hygienic conditions in buildings

Damp Proof and Fire Proof Construction

Page 239

The cavity wall construction and D.P.C. details for flat roofs is as shown in fig no 14.2

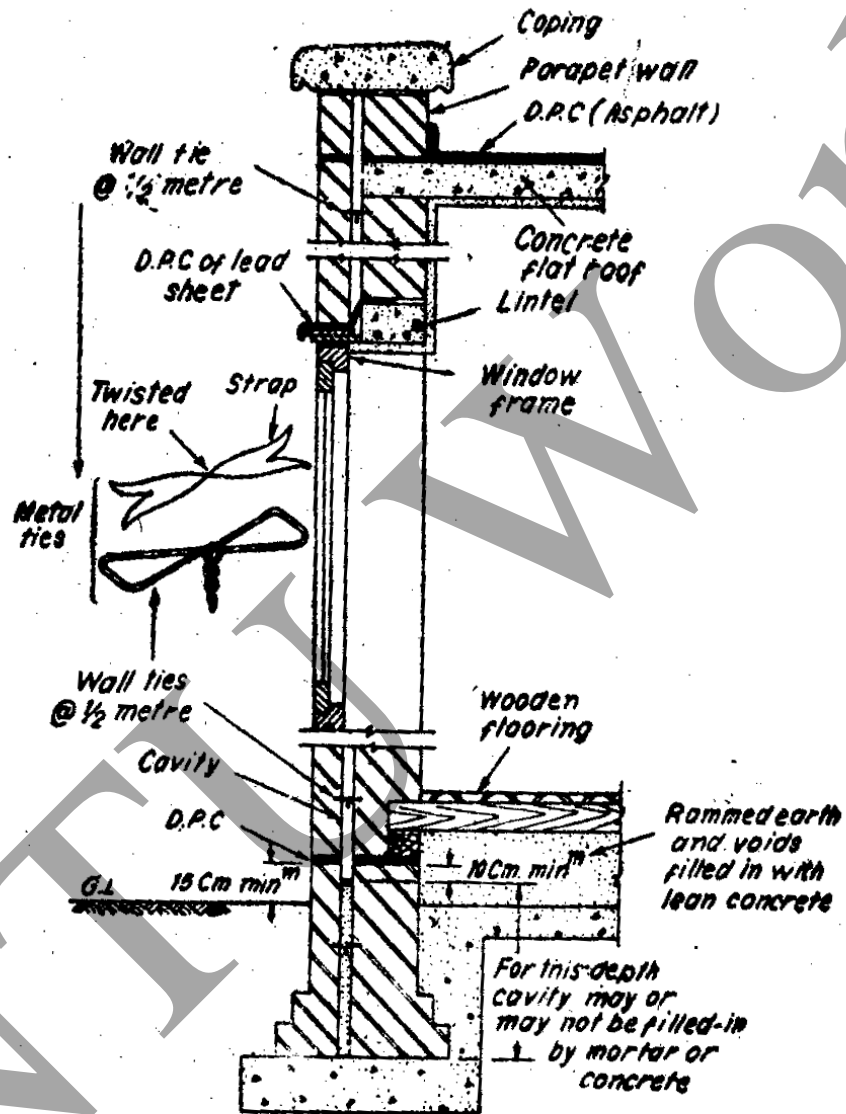

Fig 14.2 Cavity wall construction and D.P.C. details for flat roofs

5. **Guniting: (or shot concrete)** : The technique of guniting consists in forming an impervious layer of rich cement mortar (1:3) or fine aggregate mix for water proofing over the exposed concrete surface or over the pipes, cisterns etc for resisting the water pressure. By this technique, an impervious layer of high compressive strength (600 to 700 kg/cm²) is obtained and hence this is also very useful for reconditioning or repairing old concrete works
6. **Pressure grouting or (cementation)**. The mixture of cement, sand and water under pressure into the cracks, voids or fissures present in the structural component or the ground. In general, the foundations are given this treatment to avoid the moisture penetration. This technique also used for repairing structures, consolidating ground to improve bearing capacity, forming water cut-offs to prevent seepage etc.

Fire protection:

It is defined as the protection of the occupants of the building, contents and structure of the building and adjacent buildings from the risks of fire and spread of fire. The objective is achieved by using fire-resistive materials in the construction. By suitable planning of the building internally and in relation to adjacent building internally and in relation to adjacent building and by providing suitable means of quick escape for the occupants. These measures are essential to minimize the spread of fire and limit the total damage to a minimum

Damp Proof and Fire Proof Construction

Page 241

14.4 Important considerations in fire protection:

1. It should be the objective of every engineer and architect while planning and designing the building that the structure offer sufficient resistance against fire so as to afford protection to the occupants, use of fire-resisting materials and construction techniques and providing quick and safe means of escape in the building.
2. All the structural elements such as floors, walls, columns, beams etc should be made of fire resisting materials
3. The construction of structural elements such as walls, floors, columns, lintels, arches etc should be made in such a way that they should continue to function atleast for the time, which may be sufficient for occupants to escape safely in times of fire.
4. The building should be so planned or oriented that the elements of construction or building components can with stand fire for a given time depending upon the size and use of building, to isolate various compartments so as to minimize the spread of fire suitable separation is necessary to prevent fire, gases, and smoke from spreading rapidly through corridors, staircases left shafts etc.
5. Adequate means of escape are provided for occupants to leave the building quickly and safely in terms of outbreak of fire.
6. In multi-storeyed office buildings suitable equipment for detecting, extinguishing and warning of fire should be installed in the niches.

14.4 Fire-resistant construction:

National building code classifies the construction into four classes, namely type 1, type 2, type 3 and type 4 on the basis of fire-resistance offered by building components for 4-hours, 3-hours, 2-hours and 1-hour respectively. To achieve the objective of fire-resistance, due considerations should be made in design and construction of the structural members and use of combustible material should be avoided as far as possible in the construction

- a) Walls and columns
- b) Floor and roofs
- c) Wall openings
- d) Building fire escape elements (i.e.,) stair, staircase, corridors, entrances etc.

a) **Walls and columns:** The load-bearing non-load bearing walls should be plastered with fire resistive mortar to improve fire resistance. Normally 20cm thick common wall is sufficient from fire resistance point of view. Bricks should be preferred to stones if the construction is solid bearing wall. If it happens to be a framed structure then R.C.C. frames are preferred to those of steel frame. Partition walls, should also be fire resistant materials. In case of wooden partitions are employed, they should be covered with metal lath and plaster. Sufficient cover to R.C.C. members like beams or columns should be to enable them to function satisfactorily, under the fire maximum time. It has been recommended that a cover of atleast 5cm inside the main reinforcement of structural members, like columns, girders, trusses etc, 38mm for ordinary beam, long span slabs, arches etc, 25mm for

partition walls, short spans should be provided. The fire proofing treatments, which can possibly to concrete and steel column construction are as shown in the fig 14.3.

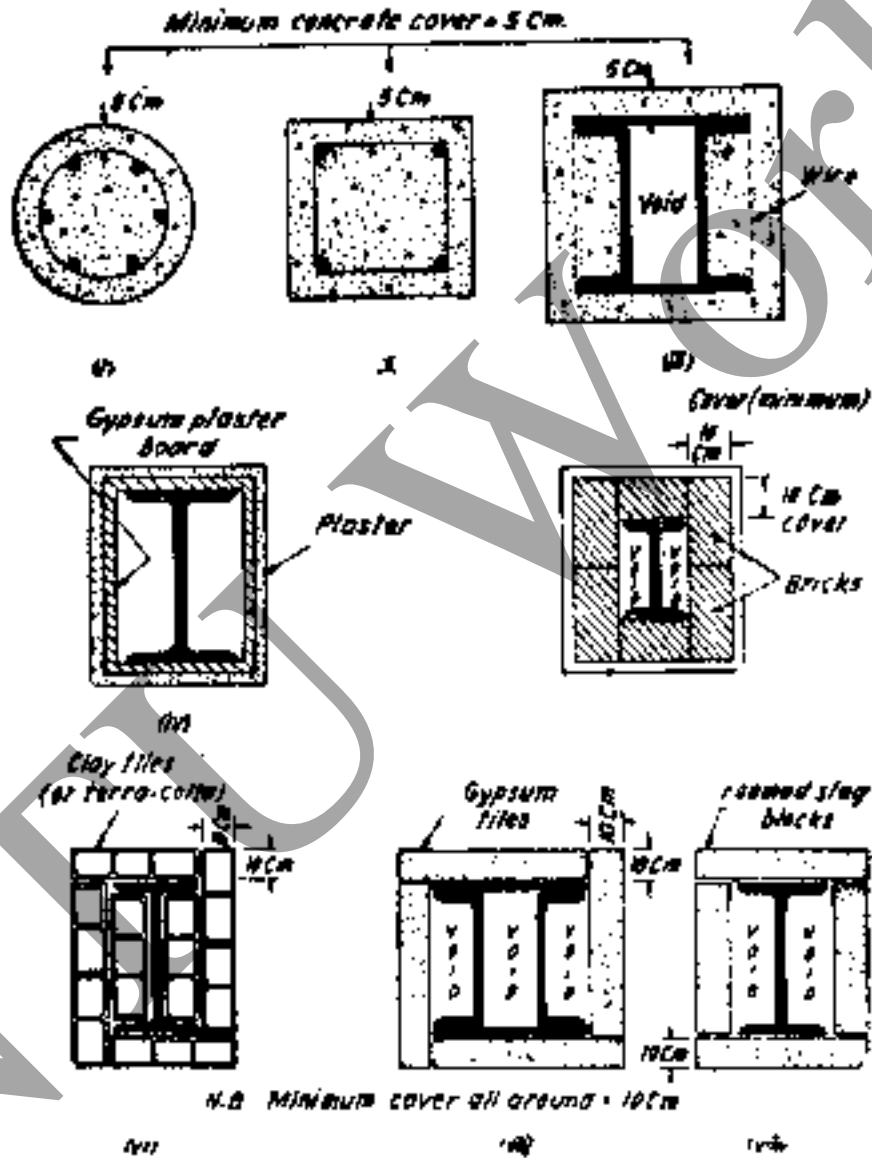
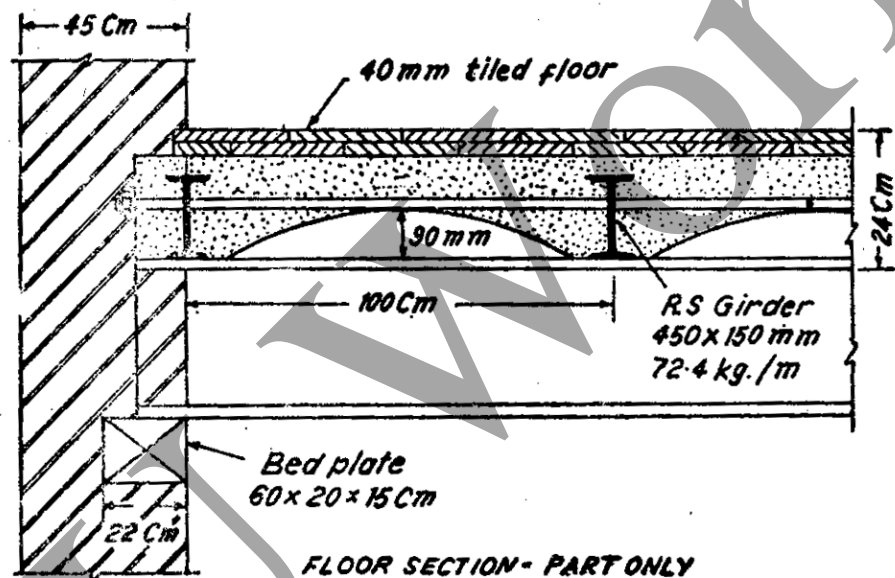

Fig 14.3 Fire proofing treatments to concrete and steel columns

- b) **Floors and roofs:** The floors and roofs should be made of fire-resisting material as they act as horizontal barriers to spread of heat and fire in vertical direction. For fire-resistant construction, the floor such as concrete jack arch floor with steel joists embedded in concrete or hollow tiled ribbed floor, R.C.C. floor etc should be used as shown in fig. 14.4.



Fire-resisting concrete Jack Arch floor.

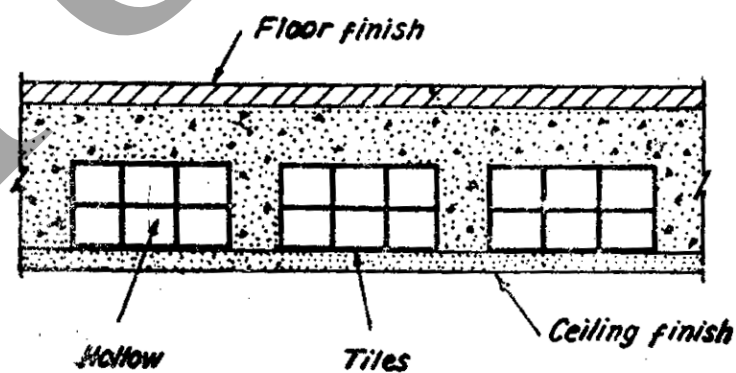

Fig 14.4 Fire-resisting in floors

- c) **Wall openings:** From fire resistance point of view, firstly the openings in the walls should be restricted to a minimum and secondly they should be protected by suitable arrangements in case of fire. These days, wire-glass panels are preferred for windows, where as steel rolling shutters are becoming popular for door ways and window openings in garages, godowns, shops etc due to their ability in preventing the spread of fire
- d) **Building fire escape element:** Staircases, corridors, Lobbies, entrances etc are the fire escape elements should be constructed out of fire-resistant materials and be well separated from the rest of the building. Doors to the staircase, corridors and lifts should be made of fire-proofing materials. Staircase should be created next to the outerwalls and should be accessible from any floor in the direction of flow towards the exits from the building.

14.5 **General measures of fire safety in building:**

In important buildings, in addition to the fire-resisting materials and adopting fire resistant construction, the following general measures of fire-safety have been recommended

- (i) Alarm system
- (ii) Fire extinguishing arrangements
- (iii) Escape routes for public buildings

SYNOPSIS

1. Damp prevention and fire protection are the chief requirements to ensure the safety of buildings against dampness and fire respectively
2. The sources of dampness are
 - (i) Faulty design of structure
 - (ii) Faulty construction or poor workmanship
 - (iii) Use of poor materials in construction
3. The effects of dampness are
 - (i) Unhealthy living and working conditions for occupants
 - (ii) Disintegration of bricks results decreasing in strength
 - (iii) Crumbling of plaster
 - (iv) Formation of colour patches on the wall
 - (v) Corrosion of metals
 - (vi) Timber get deteriorated
 - (vii) Electrical fittings gets deteriorated causing short circuit
 - (viii) Growth termites creates unhygienic conditions
4. The techniques used for damp roofing
 - (i) Use of damp proof courses

Damp Proof and Fire Proof Construction

Page 247

- (ii) Water proof or damp proof treatments
 - (iii) Cavity wall or hollow walls
 - (iv) Gunitins or shot concrete
 - (v) Pressure grouting or cementation
5. Fire protection is defined as the protection occupants of the building, contents and structure of the building and adjacent buildings from the risks of fire and spread of fire. This is achieved by using fire resistive materials in the construction by suitable planning
6. The general measures of fire safety in building are
- (i) Alarm system
 - (ii) Fire extinguish arrangements
 - (iii) Escape routes for public buildings

SHORT ANSWER QUESTIONS

1. Define damp prevention
2. What is D.P.C. ? Give examples.
3. What are the important sources of dampness?
4. Name any four effects of dampness
5. Name any four methods of preventing dampness
6. Define fire protection
7. What are the general methods of fire safety in buildings?
8. What are the properties of ideal fire resisting material?

ESSAY TYPE QUESTIONS

1. Explain the sources of dampness.
2. Explain the effects of dampness.
3. Explain the methods of preventing dampness
4. Explain the fire-resisting properties of the following material
 - a. Timber
 - b. Stone
 - c. Bricks
 - d. Concrete
5. Explain fire-resistance construction
6. Explain the general measures of fire safety in buildings.

* * *